

**CURTISS -  
WRIGHT**



**PG DRIVES TECHNOLOGY**

**R-NET CJSM2**

**TECHNICAL MANUAL**

**SK81302-04**



© Curtiss-Wright 2016

All rights reserved.

This manual is furnished under copyright and may only be used in accordance with the terms laid out by Curtiss-Wright.

The information in this manual is furnished for informational use only, is subject to change without notice, and should not be construed as a commitment by Curtiss-Wright.

Except as permitted by such terms, no part of this manual may be reproduced, stored in a retrieval system, or transmitted, in any form or by any means electronic, mechanical, recording, or otherwise - without the prior written permission of Curtiss-Wright. +44.1425.271444



**TABLE OF CONTENTS**

About this manual .....6

**CHAPTER 1 - OPERATION.....7**

1 Introduction.....7

2 Controls .....8

- 2.1 Joystick..... 8
- 2.2 External Jack Sockets ..... 8
  - 2.2.1 External On/Off Switch Jack..... 8
  - 2.2.2 External Profile/Mode Switch Jack ..... 9
- 2.3 Paddle Switches and Buttons..... 9
  - 2.3.1 On/Off Paddle Switch ..... 10
  - 2.3.2 Profile/Mode Paddle Switch ..... 10
  - 2.3.3 Speed Paddle ..... 10
- 2.4 Horn Button ..... 10
- 2.5 Profile Button..... 10
- 2.6 Mode Button..... 11
- 2.7 Screen Buttons..... 11
- 2.8 Light Sensor ..... 11
- 2.9 LCD Diagnostic LED ..... 11
- 2.10 LCD Screen ..... 12
- 2.11 IR Transmitter & Receiver ..... 12
- 2.12 Charger Socket ..... 12

3 LCD Screen.....13

- 3.1 Battery Indicator ..... 13
- 3.2 Information Bar..... 13
  - 3.2.1 Focus..... 14
  - 3.2.2 Bluetooth Signal Icon ..... 14
  - 3.2.3 Motor Temperature..... 14
  - 3.2.4 Control System Temperature ..... 14
  - 3.2.5 Clock ..... 14
- 3.3 Text Bar ..... 15
- 3.4 Main Screen Area..... 15
  - 3.4.1 Drive Mode Screen ..... 15
    - 3.4.1.1 Current Profile ..... 15
    - 3.4.1.2 Speed Indicator ..... 15
    - 3.4.1.3 Digital Speed Display ..... 16
    - 3.4.1.3 Max Speed Indicator ..... 16

- 3.4.1.4 Odometer .....16
- 3.4.1.5 Inhibit .....16
- 3.4.1.6 Latched Drive .....17
- 3.4.1.7 Momentary Screens .....17
- 3.4.2 Seating Mode Screen .....17
  - 3.4.2.1 Latched Seating Control .....18
- 3.5 Bluetooth Mode Screens .....18
  - 3.5.1 Bluetooth Screen Programming .....18
  - 3.5.2 Disconnecting a Bluetooth Device .....19
  - 3.5.3 Flight-Safe Mode .....19
- 3.6 General Information Symbols.....19
  - 3.6.1 Limp .....19
  - 3.6.2 Timer .....19
  - 3.6.3 Restart .....19
  - 3.6.4 Sleep .....20
  - 3.6.5 Cross & Tick .....20
  - 3.6.6 E-stop.....20
  - 3.6.7 Joystick Displaced .....21
  - 3.6.8 Control System Locked .....21
  - 3.6.9 Diagnostic Screen .....21
- 3.7 Settings Menu.....22
  - 3.7.1 Time .....22
  - 3.7.3 Distance .....22
  - 3.7.3 Backlight .....22
  - 3.7.4 Bluetooth.....23
  - 3.7.5 IR Setup.....23
  - 3.7.5 Programming.....23
  - 3.7.7 Exit .....23

4 Getting Ready to Drive ..... 24

**CHAPTER 2 - INSTALLATION ..... 25**

1 Introduction..... 25

2 Mounting ..... 25

- 2.1 Joystick Module Mounting .....25
  - 2.1.1 General .....25
  - 2.1.2 Orientation .....25

3 External Jack Sockets ..... 26



- 3.1 External On/Off Switch Jack..... 26
- 3.2 External Profile/Mode Switch Jack ..... 26
  - 3.2.1 Profile/Mode Select ..... 26
  - 3.2.2 Actuator Control ..... 27
  - 3.2.3 Latched Emergency Stop Switch ..... 28
  - 3.2.4 Bluetooth External Switch 1 and Bluetooth External Switch 2 ..... 28

**4 Changing the Operation of CJSM2 Paddle Switches.....28**

- 4.1 Alternative Keypad Options ..... 28
- 4.2 Changing the Keypad ..... 28

**CHAPTER 3 – PROGRAMMING .....31**

**1 Introduction.....31**

- Controls – Global..... 31
  - 1.1 Horn Volume..... 31
  - 1.2 External Profile Jack Detect ..... 31
  - 1.3 External On/Off Jack Detect..... 32
- Controls – External Profile Jack Function..... 32
  - 1.4 Profile/Mode Jack, Actuator Switches, Emergency Stop Switch, Bluetooth External Switches ..... 32
- Controls – Speed Paddles..... 33
  - 1.5 Speed Paddle Operation ..... 33
  - 1.6 Speed Step Size ..... 33
  - 1.7 Speed Step Rate ..... 33
  - 1.8 Speed Wrap Time..... 34
  - 1.9 Speed Wrap Delay ..... 34
  - 1.10 Speed Wrap Beep ..... 34

**CHAPTER 4 – IR SET-UP & OPERATION .....35**

**1 Introduction.....35**

- 1.1 CJSM2 operation in conjunction with an Omni-IR35
- 1.2 Interchangeability of IR codes between a CJSM2 and an Omni-IR ..... 35

**2 IR MODE Configuration .....36**

- 2.1 Configuration of IR Control Mode ..... 36
  - 2.1.1 Mode Name ..... 36
  - 2.1.2 Input ..... 36
  - 2.1.3 Output..... 36

**3 User Menu ..... 36**

**4 IR Set Up ..... 38**

- 4.1 Accessing the IR Set-Up Menu .....38
- 4.2 IR Set-Up Menu .....38

**5 Learning an IR Code ..... 39**

- 5.1 Learning an IR Code - Sequence .....41

**6 Enabling and Disabling IR Codes ..... 42**

**7 Deleting IR Codes ..... 42**

**CHAPTER 5 - IR CONFIGURATION TOOL ..... 45**

**1 Operation Initiation ..... 45**

**2 The Application Window ..... 46**

- 2.1 Drop-down Menus.....47
  - 2.1.1 File .....47
  - 2.1.2 Controller.....47
  - 2.1.3 Help .....47
- 2.2 Toolbar .....47
- 2.3 User Menu .....48
  - 2.3.1 Insert Appliance.....49
  - 2.3.2 Insert Command .....49
  - 2.3.3 Insert Sequence .....49
  - 2.3.4 Delete .....50
  - 2.3.5 Rename.....50
  - 2.3.6 Move Up .....50
  - 2.3.7 Move Down .....50
  - 2.3.8 Clear IR Code .....50
  - 2.3.9 Edit My Library .....50
  - 2.3.10 Assign from Library.....50
  - 2.3.11 Insert from Library.....51
- 2.4 Libraries .....51
  - 2.4.1 Default Library .....52
  - 2.4.2 My Library.....52
    - 2.4.2.1 Add Appliance.....53
    - 2.4.2.2 Edit Appliance.....54
    - 2.4.2.3 Delete Appliance .....54
    - 2.4.2.4 Clear All .....54

**3 Curtiss-Wright Default Menu..... 55**



**CHAPTER 6 – BLUETOOTH SET-UP & OPERATION ...57**

- 1 Introduction.....57**
  - 1.1 Operational Rules ..... 57
  - 1.2 System Configuration..... 57
  - 1.3 Bluetooth Mode Configuration..... 57
  - 1.4 Bluetooth Mode Screen Configuration ..... 58
    - 1.4.1 Settings Menu ..... 58
    - 1.4.2 PC Programmer ..... 58
- 2 Pairing With A Bluetooth Device .....59**
  - 2.1 Pairing with a Windows PC ..... 59
  - 2.2 Pairing With An Android device ..... 63
  - 2.3 Pairing with an iDevice..... 63
  - 2.4 Updating the List of Devices ..... 63
- 3 Operating a Windows PC.....64**
- 4 Operating an Android Device .....64**
  - 4.1 Considerations ..... 64
- 5 Operating an iDevice .....65**
  - 5.1 Switch Control..... 65
  - 5.2 VoiceOver ..... 67
  - 5.3 Switch Control Set-Up..... 68
  - 5.4 VoiceOver Set-Up..... 72

**CHAPTER 7 – BLUETOOTH PROGRAMMING .....73**

- 1 Introduction.....73**
  - Mouse 1/Mouse 2..... 74
    - 1.1 Forward, Reverse, Left & Right Nudge..... 74
    - 1.2 Nudge Time..... 74
    - 1.3 Pointer Speed ..... 74
    - 1.4 Pointer Acceleration ..... 75
    - 1.5 Action Beeps ..... 75
    - 1.6 Deflection Beeps ..... 75
    - 1.7 Double Click Time ..... 75
    - 1.8 Bluetooth External Switches ..... 75
    - 1.9 Device Name ..... 76
    - 1.10 Screen Graphic..... 76
  - iDevice 1/iDevice 2..... 77
    - 1.11 Voiceover ..... 77

- 1.11.1 Forward, reverse, left, right, external switch 1 & external switch 2 short .....77
- 1.11.2 Forward, reverse, left, right, external switch 1 & external switch 2 medium ..... 77
- 1.11.3 Forward, reverse, left, right, external switch 1 & external switch 2 long..... 78
- 1.12 Action Beeps.....79
- 1.13 Deflection Beeps.....79
- 1.14 Short Nudge Time .....79
- 1.15 Medium Nudge Time .....79
- 1.16 Long Nudge Time .....79
- 1.17 Device Name.....80
- 1.18 Mode .....80
- 1.19 Screen Graphic .....80

**CHAPTER 8 - SPECIFICATIONS ..... 81**

- 1 Electronic Specifications ..... 81**
- 2 Bluetooth Regulatory requirements..... 82**
  - 2.1 Risk Assessment Information .....82
    - 2.1.1 RSA 1.1:.....82
    - 2.1.2 RSA 2.2 & RSA 4.2:.....82
  - 2.2 FDA Labelling Requirements.....82
    - 2.2.1 Device Functionality: .....82
    - 2.2.2 Operating Characteristics: .....82
    - 2.2.3 Quality of Service (QoS):.....83
    - 2.2.4 Wireless Security Measures: .....83
    - 2.2.5 Addressing wireless Issues: .....83
    - 2.2.6 Coexistence Issues:.....83
    - 2.2.7 EMC and Telecommunications Standards: .....83
  - 2.2.8 Warning regarding use in the vicinity of RF sources: .....83
  - 2.3 Regulatory Information .....83
    - 2.3.1 United States .....83
    - 2.3.2 Canada .....84
    - 2.3.3 Europe .....84
    - 2.3.4 Japan.....84
    - 2.3.5 Korea .....84
    - 2.3.6 Taiwan .....85



## ABOUT THIS MANUAL

The Technical Manual gives an introduction to the R-net CJSM2 Joystick Module, it should be read in conjunction with the R-net Technical Manual SK77981.

Throughout the manual the following emphasis is used to draw the reader's attention.

**NOTE:** A general point for best practice.

**CAUTION:** A point of safety which if ignored could result in damage to the Control System or the vehicle.

**WARNING:** A point of safety which if ignored could cause injury to the individual.

Curtiss-Wright accepts no liability for any losses of any kind if the points are not followed.



## CHAPTER 1 - OPERATION

### 1 INTRODUCTION

The relevant contents of this chapter should be included in the wheelchair's operating guide. Further copies are available from Curtiss-Wright in either written or disk (Word) format. Copies should not be made without the express permission of Curtiss-Wright.

The operation of the R-net varies dependent on programming. This chapter covers all types of operation. It is the responsibility of the wheelchair manufacturer to ensure that only the relevant sections of this chapter are included in the wheelchair's operating manual.

The operation of the R-net wheelchair control system is simple and easy to understand. The control system incorporates state-of-the-art electronics, the result of many years of research, to provide you with ease of use and a very high level of safety. In common with other electronic equipment, correct handling and operation of the unit will ensure maximum reliability.

Please read this chapter carefully - it will help you to keep your wheelchair reliable and safe.

## 2 CONTROLS

The Joystick Module is available with and without lighting control. The controls are common to both; however, the lighting buttons symbols only appear on the lighting control version.

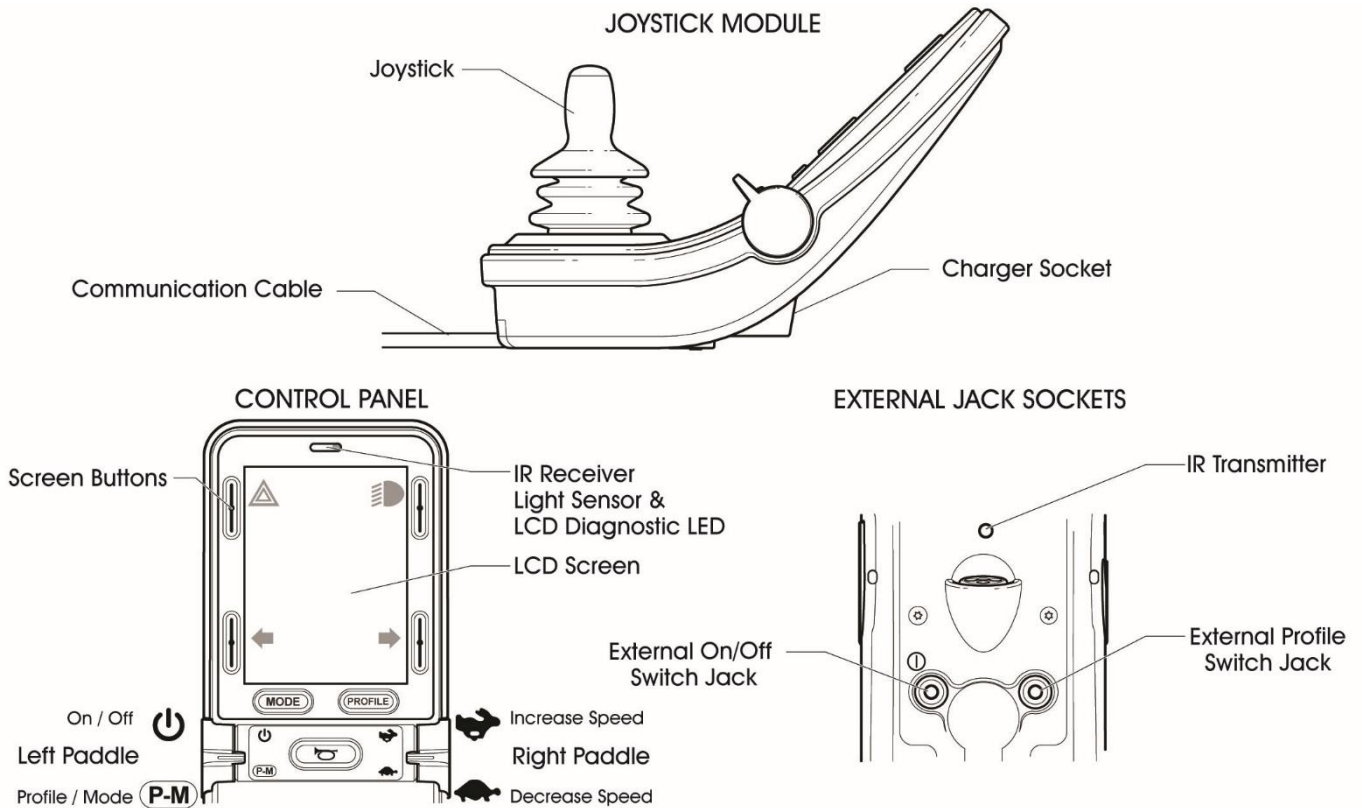

### 2.1 JOYSTICK

The primary function of the joystick is to control the speed and direction of the wheelchair. The further you push the joystick from the center position the faster the wheelchair will move. When you release the joystick the brakes are automatically applied.

### 2.2 EXTERNAL JACK SOCKETS

#### 2.2.1 EXTERNAL ON/OFF SWITCH JACK

This allows the user to turn the control system on and off using an external switch, such as a Buddy-Button.

Programming to set the operation of the control system in the event of a failure in the connected switch or its wiring to this input is available. This programming is effected via the parameter, External On/Off Jack Detect. Refer to R-net Technical Manual SK77981- Programming chapter for details.

**CAUTION**

The Joystick Module is supplied with rubber bungs that must be inserted into the Jack Socket when no external device is connected.

### 2.2.2 EXTERNAL PROFILE/MODE SWITCH JACK

This allows the user to perform the function of the Profile/Mode paddle using an external switch, such as a Buddy-Button.

If the control system is set for latched drive or latched actuator control operation, then this input will provide the Emergency Stop Switch function.

Alternative functions for this input are available via programming as described below:

- To set the operation of this input to accept a switch pad to control multiple seat actuators is available. This programming is effected via the following parameters, External Profile Switch Jack Function and Actuator Switches while Driving.
- To set the operation of this input to accept a switch pad to control Bluetooth functions is available. This programming is effected via the following parameters, External Profile Switch Jack Function and Bluetooth External Switches.
- To set the operation of the control system in the event of a failure in the connected switch or its wiring to this input is available. This programming is effected via the parameter, External Profile Jack Detect.

Refer to R-net Technical Manual SK77981 - Programming chapter for details.

**CAUTION**

The Joystick Module is supplied with rubber bungs that must be inserted into the Jack Socket when no external device is connected.

### 2.3 PADDLE SWITCHES AND BUTTONS

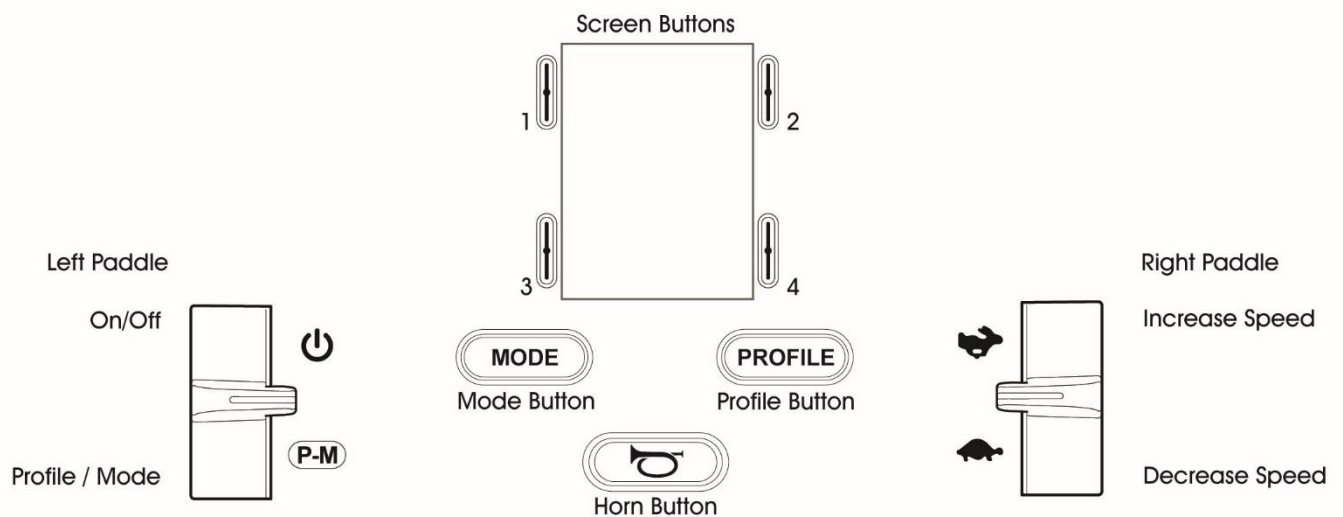



---

### 2.3.1 ON/OFF PADDLE SWITCH

The On/Off paddle switch is operated via forward deflections of the left paddle.

It is possible to program the control system to whether an audible beep occurs when an on/off operation occurs. This programming is effected via the following parameters, Start-up Beep. Refer to R-net Technical Manual SK77981- Programming chapter for details

---

### 2.3.2 PROFILE/MODE PADDLE SWITCH

The Profile/Mode paddle switch allows the user to select the available drive Profiles and operating Modes for the control system. The selection sequence is through each of the available Profiles and then each of the available Modes.

Depending on the way the control system has been programmed a momentary screen may be displayed when a new Profile is selected. Refer to section Momentary Screens for details.

The available Profiles and Modes are dependent on how the control system has been programmed and the output devices that are connected. Refer to R-net Technical Manual SK77981- Programming chapter for details

The Profile/Mode paddle switch is operated via reverse deflections of the left paddle.

---

### 2.3.3 SPEED PADDLE

The Speed Paddle allows adjustment of the control system's speed setting.

Depending on the way the control system has been programmed a momentary screen may be displayed when the paddle is operated. Refer to section Momentary Screens for details.

The default operation of the Speed paddle is momentary, i.e. the speed setting will be increased upon forward deflections of the paddle and decreased upon reverse deflections of the paddle.

Alternative programming to set the timing and operation of the Speed paddle, as well as changing it to operate continuously, i.e. in a similar way to a rotary potentiometer, is available. This programming is effected via the following parameters: Speed Paddle Operation, Speed Step Size, Speed Step Rate, Speed Wrap Time, Speed Wrap Delay and Speed Wrap Beep. Refer to R-net Technical Manual SK77981- Programming chapter for details.

---

## 2.4 HORN BUTTON

The Horn will sound while this button is depressed.

---

## 2.5 PROFILE BUTTON

The Profile button allows the user to navigate through the available Profiles for the control system. The number of available Profiles is dependent on how the control system is programmed.

Depending on the way the control system has been programmed a momentary screen may be displayed when the button is pressed. Refer to section Momentary Screens for details. Refer to R-net Technical Manual SK77981- Programming for details.

## 2.6 MODE BUTTON

The Mode button allows the user to navigate through the available Modes for the control system. The number of available Modes is dependent on how the control system is programmed.

Refer to R-net Technical Manual SK77981- Programming for details.

## 2.7 SCREEN BUTTONS

These buttons operate the lighting functions: Hazards, Lights, Left Indicator and Right Indicator.

The function of each button is illustrated by an icon displayed on the LCD screen next to the button.

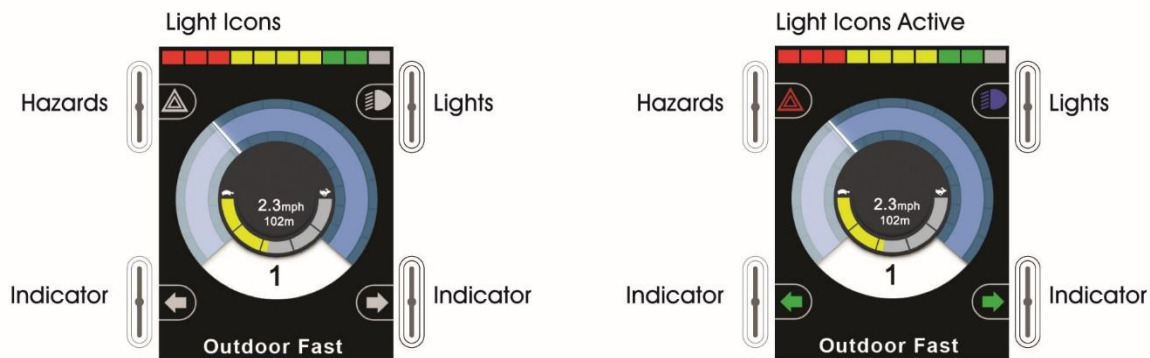

Pressing the relative button activates and deactivates its function.

Once the function is activated, the icon on the LCD will illuminate or flash depending on the function.

### NOTE

**If no lighting system is fitted to the wheelchair, these buttons will be inactive.**

**In all instances, the top left button, when held for a short time, will open the Settings Menu. Refer to section Settings Menu for more details.**

## 2.8 LIGHT SENSOR

The Joystick Module contains an ambient light sensor which automatically adjusts screen brightness. Refer to Settings Menu for programming options.

## 2.9 LCD DIAGNOSTIC LED

The purpose of this LED is to indicate the control system is switched on in the event of an LCD screen failure.



---

## 2.10 LCD SCREEN

The status of the control system can be understood by observing the LCD screen. The control system is on when the screen is backlit. Refer to section Momentary Screens for details.

---

## 2.11 IR TRANSMITTER & RECEIVER

The CJSM2 includes an IR transmitter and receiver that allows the CJSM2 to replicate commonly used IR devices, such as remote controls for TV's, DVD's, Cable/Satellite or environmental controls such as automatic door openers. Once correctly configured IR Control can be performed using the Joystick (or other Input Device) or from a Specialty Input Device that is connected to the system.

---

## 2.12 CHARGER SOCKET

This socket should only be used for charging or locking the wheelchair. Do not connect any type of programming cable into this socket.

Refer to R-net Technical Manual SK77981- Operation for details on charging.

This socket should not be used as a power supply for any other electrical device. Connection of other electrical devices may damage the control system or affect the E.M.C. performance of the wheelchair.

### **WARNING**

**The control system's warranty will be void if any device other than the battery charger supplied with the wheelchair or the lock key is connected into this socket.**

### 3 LCD SCREEN

The status of the control system can be understood by observing the LCD screen.

The screen for the R-net CJS2 has common components, which will always appear, and components that will only appear under certain conditions. Below is a view of a typical Drive screen, with and without lights.

The screen is split into four areas of information: Battery Indicator, Information Bar, Main Area and Text Bar. Each area is detailed separately in the following sections.

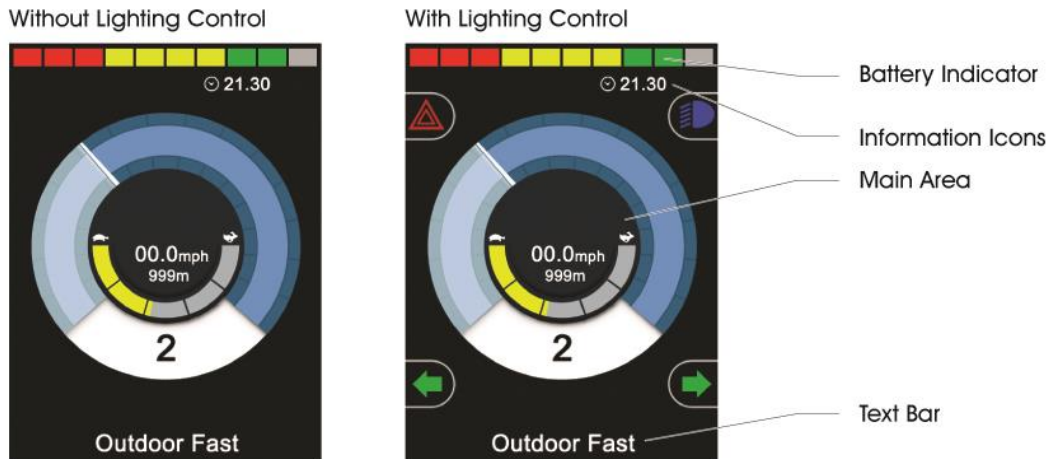

#### 3.1 BATTERY INDICATOR



This displays the charge available in the battery and can be used to alert the user to the status of the battery.

**Steady:** This indicates that all is well.

**Flashing Slowly:** The control system is functioning correctly, but you should charge the battery as soon as possible.

**Stepping Up:** The wheelchair batteries are being charged. You will not be able to drive the wheelchair until the charger is disconnected and you have switched the control system off and on again.

Refer to R-net Technical Manual SK77981- Operation for a description of how to read the Battery Gauge.

#### 3.2 INFORMATION BAR

This area contains information and warning symbols, as well as clock.

### 3.2.1 FOCUS



When the control system contains more than one method of direct control, such as a secondary Joystick Module or a Dual Attendant Module, then the Module that has control of the wheelchair will display the Focus symbol.

### 3.2.2 BLUETOOTH SIGNAL ICON



This symbol appears when Bluetooth is enabled. If the symbol is white, the system is not paired to an external Bluetooth device. If the symbol is blue, the system is paired to an external Bluetooth device. When the system has been placed into Discovery Mode, the icon will flash blue.

### 3.2.3 MOTOR TEMPERATURE



This symbol is displayed when the control system has intentionally reduced the power to the motors, in order to protect them against heat damage.

### 3.2.4 CONTROL SYSTEM TEMPERATURE



This symbol is displayed when the control system has intentionally reduced its own power, in order to protect itself against heat damage.

### 3.2.5 CLOCK



This displays the current time in a numeric format.

The clock is user adjustable. Adjustable options are:

- Visibility, whether the clock is displayed on screen.
- The display format, 12 or 24 hour.
- The time, the user can adjust the time.

These adjustments are made within the Settings Menu. Refer to section Settings Menu for more details.

### 3.3 TEXT BAR

#### Outdoor Fast

This area of the screen displays text relevant to the operating condition of the control system. Example text strings would be Profile Name, Mode Name or Axis Name. These text strings are programmable. Refer to R-net Technical Manual SK77981-Programming for more details.

### 3.4 MAIN SCREEN AREA

This area will contain different information dependent on the current operating Mode of the control system. The area is also used to display general system information, when necessary.

#### 3.4.1 DRIVE MODE SCREEN

Displays symbols relevant to the drive control of the wheelchair.

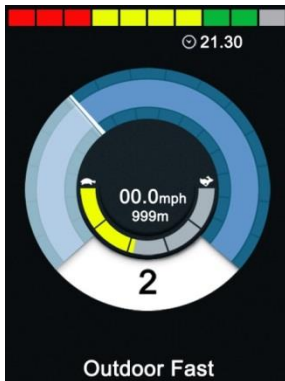

##### 3.4.1.1 CURRENT PROFILE

# 2

This denotes the currently selected Profile, shown in numeric form.

##### 3.4.1.2 SPEED INDICATOR

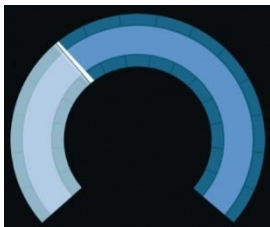

This gives a graphical display of the wheelchairs speed. As the speed increases, the needle will move around the arc, covering the background with the white highlight.



The display is scaled between zero speed and the speed corresponding to the programmable parameter, Max Displayed Speed. Refer to R-net Technical Manual SK77981- Programming chapter for more details.

#### 3.4.1.3 DIGITAL SPEED DISPLAY

**11.3mph**

This displays the actual speed of the wheelchair in digital form.

The display can be set to mph or km/h, or can be turned off. These options are set by the programmable parameter, Display Speed. Refer to R-net Technical Manual SK77981- Programming chapter for more details.

#### 3.4.1.3 MAX SPEED INDICATOR



This displays the current maximum speed setting.

When the left-hand segment is illuminated, then the speed setting corresponds to the programmed minimum forward, reverse and turning speeds. The indicator will never show a lower setting, i.e. the left-hand segment will always be fully illuminated.

When all segments are fully illuminated, then the speed setting corresponds to the programmed maximum forward, reverse and turning speeds.

#### 3.4.1.4 ODOMETER

**201m**

This displays the total distance the wheelchair has travelled or the trip distance since the last reset. This selection is made in the Settings Menu. Refer to Settings Menu further in this section of the manual.

The display can be set to mph or km/h, or can be turned off. These options are set by the same programmable parameter that affects the digital speed display, i.e. Display Speed.

Refer to R-net Technical Manual SK77981- Programming chapter for more details.

#### 3.4.1.5 INHIBIT



If the wheelchair is being inhibited from driving, then this red symbol will be flashing.

If the speed of the wheelchair is being limited, for example, by a raised seat, then this orange symbol will be displayed.

### 3.4.1.6 LATCHED DRIVE



This symbol will be displayed if the control system is set for latched drive operation.

### 3.4.1.7 MOMENTARY SCREENS

If the momentary screens are programmed to be displayed then pressing the Speed or Profile Buttons will display screens such as below.



Speed Momentary Screen



Profile Momentary Screen

### 3.4.2 SEATING MODE SCREEN

Displays symbols relevant to the seating control of the wheelchair.

Displays the sections of the chair currently selected for movement, the name given to the selection and a direction arrow showing what sort of movement is available.



Seating adjustment is achieved as follows.

- Move the joystick left or right to select the desired axis.
- Move the joystick forwards or backwards to move the seat.

### 3.4.2.1 LATCHED SEATING CONTROL



This symbol will be displayed if the control system is set for latched seating control operation.

## 3.5 BLUETOOTH MODE SCREENS

The initial Bluetooth Mode screen will be dependent on whether the CJSM2 has been set up to control one or more devices.

If set up to control just one device, a screen such as below will appear.



If set up to control more than one device, a screen such as below will appear.

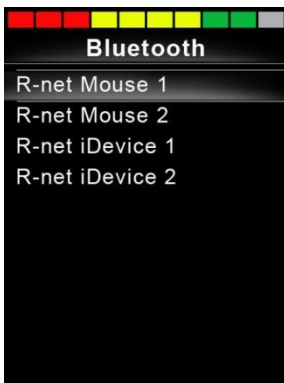

The joystick should then be used to navigate the menu and select the device to control. Forward and reverse deflections navigate the menu, while a right deflection selects the highlighted device. For further details of Bluetooth operation and programming options, refer to the Bluetooth chapter.

### 3.5.1 BLUETOOTH SCREEN PROGRAMMING

The text to describe each device can be set via the programmable parameter, Device Name.

The screen symbol for each device can be set via the programmable parameter, Screen Graphic.

Refer to chapter Bluetooth Programming for more details.

### 3.5.2 DISCONNECTING A BLUETOOTH DEVICE

Enter the Settings Menu and select Bluetooth. Set the device you wish to disconnect from to Off.

### 3.5.3 FLIGHT-SAFE MODE

It is common practice to disable wireless transmissions while on an aircraft. Enter the Settings Menu and select Bluetooth. Set all the devices to Off.

## 3.6 GENERAL INFORMATION SYMBOLS

### 3.6.1 LIMP



This message is displayed if a user switch has become disconnected and the control system is programmed to still allow drive, at a reduced rate.

### 3.6.2 TIMER

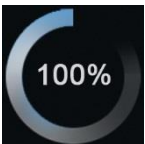

This symbol is displayed when the control system is changing between different states. An example would be entering into module re-configuration.

### 3.6.3 RESTART



When the control system requires a reboot; for example, after a module re-configuration, symbol will be flashed.

### 3.6.4 SLEEP



This symbol will be displayed for a short time before the R-net enters into a sleep state.

### 3.6.5 CROSS & TICK

These symbols will be displayed during configuration procedures.



Process completed correctly.



Process not completed correctly.

### 3.6.6 E-STOP



If the control system is programmed for latched drive or seating control operation, then it is normal for an Emergency Stop Switch to be connected into the External Profile/Mode Switch Jack.

If the Emergency Stop Switch is operated or disconnected, this symbol will be displayed.

### 3.6.7 JOYSTICK DISPLACED



If the joystick is operated before or just after you switch the control system on, the screen will flash the joystick displaced screen.

You must release and center the joystick to resume normal operation. If you do not release the joystick within five seconds the wheelchair will not be able to move, even if you release the joystick and operate it again. The screen will display a diagnostic screen at this time. You can reset this condition by switching the control system off and on again.

### 3.6.8 CONTROL SYSTEM LOCKED



This symbol is displayed if the control system is locked. Refer to R-net Technical Manual SK77981 - Operation for details of locking and unlocking.

### 3.6.9 DIAGNOSTIC SCREEN



When the control system safety circuits have operated and the control system has been prevented from moving the wheelchair a diagnostics screen will be displayed.

This indicates a system trip, i.e. the R-net has detected a problem somewhere in the wheelchair's electrical system. If the error is in a non-active module, for example in the ISM but Drive Mode is selected, then drive will still be possible, however, the diagnostic screen will appear intermittently.



Refer to R-net Technical Manual SK77981- Diagnostics for a complete description of the Trip Texts and diagnostic procedures.

### 3.7 SETTINGS MENU

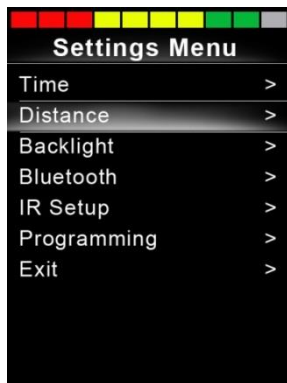

The Settings Menu allows access to user-related adjustments. The menu is accessed by depressing and holding the top left-hand Screen Button for 1 second. A typical Settings Menu display would be as above.

Each of the menu items are described in the following sections.

Joystick forward and reverse movements are used to navigate up and down the screen.

#### 3.7.1 TIME

A right joystick deflection will enter a sub-menu with the following Time related function options:

<b>Set Time</b>	Allows the user to set the current time.
<b>Display Time</b>	This sets the format of the time display or turns it off. The options are 12hr, 24hr or Off.

#### 3.7.3 DISTANCE

A right joystick deflection will enter a sub-menu with the following odometer data and function options:

<b>Total Distance</b>	This is a value held in the Power Module and relates to the total distance driven using that Power Module.
<b>Trip Distance</b>	This is a value held in the Joystick Module and relates to the total distance driven since the last reset.
<b>Display Distance</b>	Sets whether Total Distance or Trip Distance appears as the odometer display on the Joystick Module.
<b>Clear Trip Distance</b>	A right joystick deflection will clear the Trip Distance value.

#### 3.7.3 BACKLIGHT

A right joystick deflection will enter a sub-menu with the following Backlight related function options:

<b>Backlight</b>	This sets the intensity of the LCD backlight, adjustable range is 0% to 100%.
<b>Auto Backlight</b>	The Joystick Module contains an ambient light sensor to automatically adjust screen brightness. The programmable options are On or Off. If set to On, the display adjusts the screen brightness

based on the light sensor reading. If set to Off the screen brightness will not change with changes in light intensity.

**Backlight Timeout**

This adjusts the period of time the backlight will remain active once no further instructions are received from an input device, adjustable between 0 and 240 seconds.

**3.7.4 BLUETOOTH**

A right deflection of the joystick will enter a sub-menu to configure the Bluetooth Mode screen.

Refer to chapter Bluetooth Set-up & Operation for more details.

**3.7.5 IR SETUP**

A right deflection of the joystick will enter a sub-menu for learning and deleting IR codes.

Refer to chapter IR Set-up & Operation for more details.

**3.7.5 PROGRAMMING**

A right deflection of the joystick will enter a sub-menu for programming user experience functions as follows:

- Sleep** Sets the time after which the control system will go to sleep if an Input Device command is not received.
- Sounder Volume** Sets the volume of the sounder used to indicate button presses.
- Horn Volume** Sets the volume of the horn when used.
- Start-up Beep** Sets whether a short beep occurs when the controller is turned on.
- Momentary Screens** Sets whether programmed Momentary Screens are displayed.
- Display Speed** Sets how the wheelchairs speed is displayed; options are mph, km/h or off.
- Displays** Sets the format of the digital drive display; options are odometer, speed or both
- Diagnostics** Allows the user to read diagnostic information from the control system.

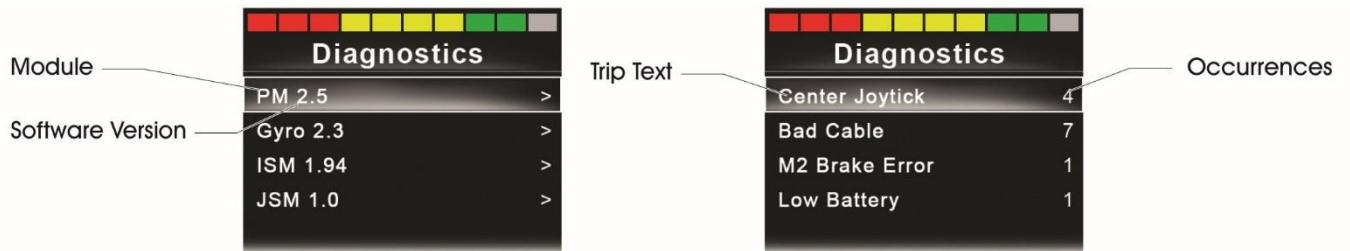

**Timers**

Enables the user to view how many hours the chair has been driven for.

**3.7.7 EXIT**

Exits the Settings Menu.



## 4 GETTING READY TO DRIVE

Operate the On/Off paddle. The screen will go through an initializing process then show the base screen as follows

- Check that the Speed Setting is at a level that suits you.
- Push the joystick to control the speed and direction of the wheelchair.

### NOTE

If you push the joystick before or just after you switch the control system on, the screen will flash the joystick displaced screen. You must release and center the joystick to resume normal operation. If you do not release the joystick within five seconds the wheelchair will not be able to move, even if you release the joystick and push it again. The screen will display the diagnostic screen at this time. You can reset this condition by switching the control system off and on again.



If you do not push the joystick as you switch the wheelchair on and the diagnostic screen is displayed, as in the following diagram, then the R-net has detected a problem somewhere in the wheelchair's electrical system.



## CHAPTER 2 - INSTALLATION

### 1 INTRODUCTION

This chapter covers only aspects of installation that are unique to the R-net CJS2.

For all other aspects of Joystick Module installation, please refer to R-net Technical Manual SK77981.

### 2 MOUNTING

#### 2.1 JOYSTICK MODULE MOUNTING

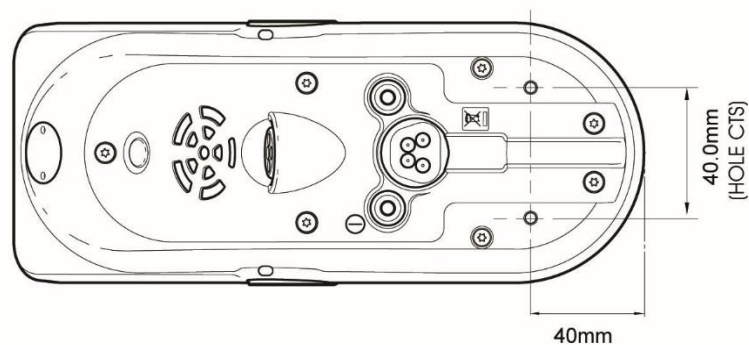

##### 2.1.1 GENERAL

The Joystick Module should be secured using two M5 screws with a maximum penetration of 12mm.

**NOTE**

**Do not overtighten the screws. See data sheet for further information.**

##### 2.1.2 ORIENTATION

The Joystick Module must be mounted with the joystick shaft pointing vertically upwards. If you want to use any other mounting alternatives then contact Curtiss-Wright.

### 3 EXTERNAL JACK SOCKETS

#### 3.1 EXTERNAL ON/OFF SWITCH JACK

This input will accept a standard normally-open switch and a normally-open switch that contains a resistor network. The type of switch circuit that will be accepted is set by the programmable parameter, External On/Off Jack Detect. This parameter also sets the operation of the system in the event of an error being detected in the connected switch or its wiring.

Refer to R-net Technical Manual SK77981 - Programming for more details.

#### 3.2 EXTERNAL PROFILE/MODE SWITCH JACK

This is a stereo jack socket with its contacts identified as below.

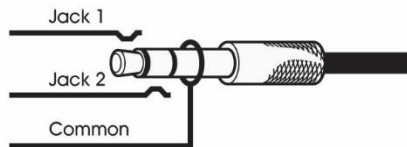

This input will accept a normally open-switch, a normally-closed switch, a normally-open switch that contains a resistor network and an array of normally-open switches and resistors; the latter to control multiple seat actuators, which support a variety of functions set by the programmable parameters, Profile/Mode Jack, Actuator Switches, Emergency Stop Switch and Bluetooth External Switches. In addition, if a single-switch function is selected, the programmable parameter, External Profile Jack Detect, will set the type of switch circuit that will be accepted. Refer to R-net Technical Manual SK77981 -Programming for more details.

The required connections to suit each function are shown in the table below.

Active Jack Function	Jack 1	Jack2	Common
Profile/Mode Select	✓		✓
Actuator Control		✓	✓
Latched Emergency Stop	✓		✓
Bluetooth External Switch 1	✓		✓
Bluetooth External Switch 2		✓	✓

Switch circuit details are given below.

##### 3.2.1 PROFILE/MODE SELECT

A normally-open switch connected between Jack 1 and Common.

### 3.2.2 ACTUATOR CONTROL

An array of normally-open switches and resistors, as shown in the diagram below, connected between Jack 2 and Common.

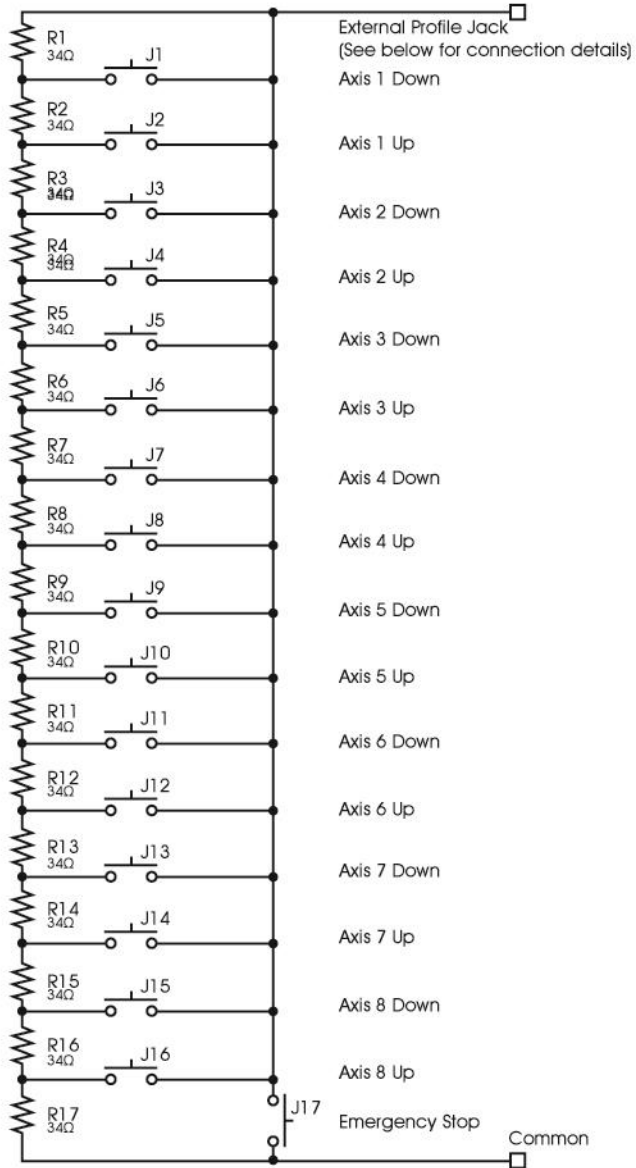

Switch Network for Actuator Control

All resistors 0.1% tolerance

#### NOTE

It is the responsibility of the wheelchair OEM to undertake a risk assessment to determine if hazardous conditions can result from defects in the switch/resistor array or its wiring. Curtiss-Wright accept no liability for losses of any kind arising from the control of actuators from a switch/resistor array.

### 3.2.3 LATCHED EMERGENCY STOP SWITCH

A normally-closed switch connected between Jack 1 and Common.

### 3.2.4 BLUETOOTH EXTERNAL SWITCH 1 AND BLUETOOTH EXTERNAL SWITCH 2

A normally-open switch or switches connected between Jack 1 or Jack 2 and Common respectively.

## 4 CHANGING THE OPERATION OF CJSM2 PADDLE SWITCHES

To suit individual user preferences, it may be desirable to change the function of the left and right paddle switches. This can be achieved by adjusting switches located either side of the Horn button and fitting an alternative keypad. See the following sections for more details.

### 4.1 ALTERNATIVE KEYPAD OPTIONS

The following keypad options are available. Order using the part numbers as shown below.



### 4.2 CHANGING THE KEYPAD

Each keypad contains a legend that identifies the switch position that should be set for the alternative user controls. See example below.



#### Changing the paddle switch function

- Disconnect the CJSM2 from the rest of the R-net system.
- Carefully remove the horn keypad located between the two paddle switches. Clean away any excess adhesive or debris.
- Locate the switches underneath the keypad.



- Each keypad identifies the switch position that should be set for the alternative user controls. See example below.
- Set the switches to the positions identified on the keypad.
- Place the keypad into the recess. Note: Do not remove the adhesive backing. Re-connect the CJSM2 and turn the R-net system on.
- Once the system is configured, verify that the paddle operation matches the legend on the keypad.
- Once satisfied that the operation is correct, turn the control system off and disconnect the CJSM2 from the system.
- Remove the keypad from its recess.
- Remove the adhesive backing from the keypad and place the keypad firmly into its recess.
- Turn the control system on and verify the correct operation of the paddle switches.

**WARNING**

Any replacement work carried out without the wheelchair manufacturer's permission may invalidate the control system's warranty. Keypad replacement should only be conducted by healthcare professionals with in-depth knowledge of wheelchair control systems. Curtiss-Wright accepts no liability for losses of any kind if the procedure and safety guidelines are not followed.

**CAUTION**

Incorrect fitting of the Keypad could seriously affect the Joystick Module's resistance to moisture ingress

While performing the following operations, the technician should use anti-static protection such as the RadioShack 276-2397 or Farnell 8247056 anti-static wristbands. Curtiss-Wright recommends anti-static protection to specification IEC 61340-5-2. Failure to use the correct anti-static protection could cause damage to the control system. Curtiss-Wright accepts no liability for losses of any kind if the correct anti-static protection measures are not followed.





## CHAPTER 3 – PROGRAMMING

### 1 INTRODUCTION

This section covers programmable parameters which are specific to the CISM2. For parameters which are shared with the CISM1, refer to the R-net Technical Manual SK77981 - Programming.

#### Controls

##### Global

Horn Volume	<i>Sets the Volume of the horn output on the CISM2</i>
External Profile Jack Detect	<i>Sets the type of switch the CISM2 expects to be connected to the External Profile Switch Jack</i>
External On/Off Jack Detect	<i>Sets the type of switch the CISM2 expects to be connected to the External On/Off Switch Jack</i>
External Profile Jack Function	
Profile/Mode Jack	<i>Sets the type of jack the CISM2 expects to be connected to the External Profile Switch Jack</i>
Actuator Switches	<i>Sets the function of the external profile jack</i>
Emergency Stop Switch	<i>Sets whether a normally closed Emergency Stop Switch should be fitted when a latched operation is programmed</i>
Bluetooth External Switches	<i>Sets if a switch connected to the CISM2 Profile/Mode jack socket controls Bluetooth functions</i>

##### Speed Paddles

Speed Paddle Operation	<i>Sets whether speed adjustment is via a momentary or continuous operation of the CISM2's Speed Paddle</i>
Speed Step Size	<i>Sets by how much the speed setting will change when the CISM2's Speed Paddle is operated</i>
Speed Step Rate	<i>Sets the rate at which speed setting changes occur when the Speed Paddle is deflected</i>
Speed Wrap Time	<i>Sets a time delay between the speed setting wrapping from maximum to minimum.</i>
Speed Wrap Delay	<i>Sets a time delay after a wrap before the speed setting increases from the minimum level</i>
Speed Wrap Beep	<i>Sets whether there is an audible beep when the CISM2's speed setting wraps from maximum to minimum</i>

### CONTROLS – GLOBAL

#### 1.1 HORN VOLUME

This sets the volume of the audible feedback given whenever the Horn button on the CISM2 is operated.

The programmable options are Low, Medium and High.

The default value is Low, which is equivalent to all other R-net Joystick Modules. Setting the Horn Volume to Medium or High will give a progressively louder sound.

Horn Volume is accessible via the user setting menu, where the programmable options 1,2 and 3 are equivalent to Low, Medium and High.

#### 1.2 EXTERNAL PROFILE JACK DETECT

This sets the type of switch the CISM2 expects to be connected to the External Profile Switch Jack.

The programmable options are On and Off.

If set to On, the CISM2 will expect a switch with a 220Ohm resistor connected in series with its contacts and a 2700hm resistor connected across its contacts to be connected to the External Profile Switch Jack, so will be able to detect both open- and short-circuits in the switch or its wiring. If such conditions are detected, the function associated with the External Profile Switch Jack will be disabled and a warning displayed on the screen.

**NOTE**

To maximise the error-checking capability, the resistors must be fitted as physically close as possible to the switch contacts.

If set to Off, the CJSM2 will not check for errors in the external circuitry connected to the External Profile Switch Jack and a standard external switch can be used.

**WARNING**

PGDT recommend that if seat actuators are driven using this input and a single switch, then the switch must be fitted with resistors as described above. PGDT accept no liability for losses of any kind arising from the use of any other switch.

### 1.3 EXTERNAL ON/OFF JACK DETECT

This sets the type of switch the CJSM2 expects to be connected to the External On/Off Switch Jack, and the subsequent behavior of the system.

The programmable options are On, Off and Limp.

If set to On, the CJSM2 will expect a switch with a 220Ohm resistor connected in series with its contacts and a 2700hm resistor connected across its contacts to be connected to the External On/Off Switch Jack, so will be able to detect both open- and short-circuits in the switch or its wiring. If such conditions are detected, a trip will occur.

**NOTE**

To maximise the error-checking capability, the resistors must be fitted as physically close as possible to the switch contacts.

If set to Off, the CJSM2 will not check for errors in the external circuitry connected to the External On/Off Switch Jack and a standard external switch can be used.

If set to Limp, the CJSM2 will expect a switch with a 220Ohm resistor connected in series with its contacts and a 2700hm resistor connected across its contacts to be connected to the External On/Off Switch Jack, so will be able to detect both open- and short-circuit in the switch or its wiring. If such conditions are detected, the system will still allow drive but at a reduced speed and will issue visual and audible warning.

**WARNING**

PGDT recommend the switch must be fitted with resistors as described above. PGDT accept no liability for losses of any kind arising from the use of any other switch.

## CONTROLS – EXTERNAL PROFILE JACK FUNCTION

### 1.4 PROFILE/MODE JACK, ACTUATOR SWITCHES, EMERGENCY STOP SWITCH, BLUETOOTH EXTERNAL SWITCHES

These four parameters are closely related, so are covered in one section.

The External Profile Switch Jack can support a number of different functions:

- Sequential selection of Profiles and Modes via a normally-open switch
- Control of up to eight seat actuators via an array of normally-open switches and resistors
- Emergency stop function via a normally-closed switch if a Latched operation is set
- Bluetooth functions via one or two normally-open switch(es)



The active function is set by the programmed-combination of these four parameters and is explained in the following table.

Active Jack Function	Profile/Mode Jack	Actuator Switches	Emergency Stop Switch	Bluetooth External Switches
<b>Profile/Mode</b>	1	No	Yes	No
<b>Actuator Control</b>	1	Yes	Yes	No
<b>Latched E-Stop*</b>	1	No	Yes	No
<b>1x Bluetooth Switch</b>	1	No	Yes	Yes
<b>2x Bluetooth Switches</b>	2	No	Yes	Yes

\* Requires a Latched operation to be set

For details jack plug wiring for each of the options, refer to the Installation chapter 2

## CONTROLS – SPEED PADDLES

### 1.5 Speed Paddle Operation

This sets whether speed adjustment is via a momentary or continuous operation of the CJSM2's Speed Paddle.

The programmable options are Momentary and Continuous.

If set to Momentary, the speed setting change occurs upon the initial deflection, rather than on the release the Speed Paddle will adjust the speed setting by the programmed value of parameter Speed Step Size.

If set to Continuous, while the Speed Paddle is held deflected the speed setting will change by the programmed value of parameter Speed Step Size at a rate defined by the programmed value of parameter Speed Step Rate.

### 1.6 SPEED STEP SIZE

This sets by how much the speed setting will change when the CJSM2's Speed Paddle is operated.

The programmable range is 1% to 80% in steps of 1%.

The term operation is defined by the programmed setting of parameter Speed Paddle Operation.

If that parameter is set to Momentary, then an operation is a single deflection of the Speed Paddle.

If that parameter is set to Continuous, then an operation is a continuous deflection of the Speed Paddle for the programmed value of parameter Speed Step Rate, and will auto-repeat.

### 1.7 SPEED STEP RATE

This sets the rate at which speed setting changes occur when the Speed Paddle is deflected.

The programmable range is 0.02 to 5.00 seconds in steps of 0.02 seconds.

This parameter is only effective when parameter Speed Paddle Operation is set to Continuous.



---

### 1.8 SPEED WRAP TIME

This sets a time delay between the speed setting wrapping from maximum to minimum. The purpose is to prevent inadvertent wraps, i.e. the user accidentally 'overshooting' the maximum speed setting.

The programmable range is 0 to 30 seconds in steps of 1 second. If set to 0, then no wrapping will occur.

---

### 1.9 SPEED WRAP DELAY

This sets a time delay after a wrap before the speed setting increases from the minimum level.

The programmable range is 1 to 10 seconds in steps of 0.5 seconds.

---

### 1.10 SPEED WRAP BEEP

This sets whether there is an audible beep when the CJSM2's speed setting wraps from maximum to minimum.

The programmable options are Yes and No.

## CHAPTER 4 – IR SET-UP & OPERATION

### 1 INTRODUCTION

The CJSM2 includes an IR transmitter and receiver to replicate commonly used IR devices, such as remote controls for TV's, DVD's, Cable/Satellite or environmental controls such as automatic door openers.



#### 1.1 CJSM2 OPERATION IN CONJUNCTION WITH AN OMNI-IR

If there are two devices with IR connected into a system, for example a CJSM2 and an Omni-IR, only one of the devices can have IR codes stored in it. If there are IR codes in both devices, then IR Mode will not be accessible.

If a CJSM2 and an Omni-IR are connected into a system, the Omni-IR's learning function is disabled and IR codes must be learnt through the CJSM2.

#### 1.2 INTERCHANGEABILITY OF IR CODES BETWEEN A CJSM2 AND AN OMNI-IR

To ensure the CJSM2 supports a greater number of modern-day IR appliances, the storage format of its IR codes is different to that of the Omni-IR. Therefore, it is not possible to use the IR Configurator to exchange IR codes between the devices.



## 2 IR MODE CONFIGURATION

### 2.1 CONFIGURATION OF IR CONTROL MODE

Curtiss-Wright factory programming configures Mode 7 to be IR Control Mode. If this programming has been overwritten, then it may be necessary to re-program as described below. You will know if re-programming is necessary if you cannot access the IR User Menu when it has learnt Codes. In this instance, programming as below is recommended.

Firstly, select a Mode to use for IR Control. In the example below it is Mode 5.

Profile Management	Profile 1	Profile 2	Profile 3	Profile 4	Profile 5	Profile 6
Configuration	Mode 1	Mode 2	Mode 3	Mode 4	Mode 5	Mode 6
Mode Name	Drive	Seating	Bluetooth	Environmental	Mode 5	Mode 6
Input	Drive	Seating	Raw	Raw	Raw	Raw
Output	Drive	Seating	Mouse	Environmental	Drive	Output 6
Speeds	Profile 1	Profile 2	Profile 3	Profile 4	Profile 5	Profile 6
Controls					Drive	Profile 6
Latched	Profile 1	Profile 2	Profile 3	Profile 4	Seating	Profile 6
Seating					Environmental	
Battery					Programming	
General					Mouse	
Motor					Output 3	
					Output 4	
					Output 5	
					Output 6	
					Output 7	
					IR Control	

#### 2.1.1 MODE NAME

This is a 20-character text string that sets the name of the selected Mode. The sample screen above shows it as still being named Mode 7, but it could be changed to something more specific, such as IR Control

#### 2.1.2 INPUT

This parameter should be set Raw.

#### 2.1.3 OUTPUT

This parameter should be set to IR Control.

## 3 USER MENU

IR Control Mode is accessed in the normal way of Mode selection, i.e. operation of the R-net system’s Mode button or Command.

IR Control Mode will only be available if IR Codes have been stored in the CJSM2. There are two ways to store IR Codes in the CJSM2: by ‘learning’ Codes from IR handsets; or by programming from the PC based IR Configuration Tool. Refer to section IR Set Up or chapter IR Configuration Tool for respective details of each method.

When a CJSM2 is dispatched from Curtiss-Wright there are no stored IR Codes.

#### NOTE

**If IR Mode is not available and there are stored IR Codes, then refer to section Configuration of IR Control Mode.**



On entering IR Mode the user will be presented with a list of available IR Appliances, such as below.



When a CJSM2 is dispatched from Curtiss-Wright, it will contain a default menu. If required, the IR Configuration tool can be used to change this default menu.

Navigate the User Menu as below:

- Forward joystick deflections will highlight the Appliance above.
- Reverse joystick deflections will highlight the Appliance below.
- Left or Right joystick deflections will enter the highlighted Appliance's sub-menu, which will contain all the IR Commands for that Appliance
- Left or Right joystick deflections will then activate the highlighted IR Command.

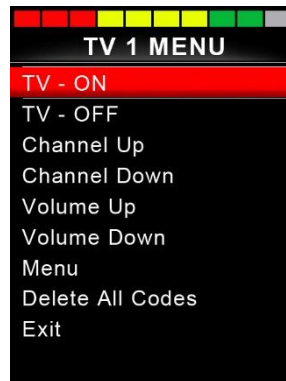

For each Appliance there is a list of associated IR Commands. Using the TV example, Commands such as: TV – ON, TV – OFF, Channel Up, Channel Down, Volume Up and Volume Down may be displayed. When the CJSM2 is transmitting the selected Command, it is highlighted with a red background.

## 4 IR SET UP

### 4.1 ACCESSING THE IR SET-UP MENU

There are two methods of accessing the IR Set-up Menu on the CJSM2.

- Via the Settings menu, refer to chapter Operation.
- Via On-Board Programming, refer to the R-net Technical Manual SK77981 - Programming.

### 4.2 IR SET-UP MENU

On entering the IR Set-up Menu, the default Appliances will appear. By selecting an Appliance, then its Commands will be shown.



If a Command is checked, this means it has a stored IR Code. If there is not a check, then there is no stored IR Code for that Command. IR Codes can be stored or deleted as detailed in the following sections.



## 5 LEARNING AN IR CODE

Enter the IR Set-up Menu.

Select an Appliance. E.g. TV – Samsung



The Commands for the Appliance will appear on the screen as below.

Select the Command to be learnt, via a right deflection of the joystick. In this example, TV > Channel Up.



Select Learn Code, via a right deflection of the joystick while the Command is highlighted.



Point the TV remote control at the CJSM2 Receiver LED and press the Channel Up button twice.



A check denotes a successful learn operation.

A cross denotes an unsuccessful learn operation, please retry.



After the code is learnt highlight Exit and deflect the joystick to the left. This will return the system to the Appliance level of the IR Set-up Menu.

#### NOTE

**The first time an IR Code has been learnt, it is necessary to cycle the power to the CJSM2. If other IR Codes are already learnt, then this is not necessary.**

## 5.1 LEARNING AN IR CODE - SEQUENCE

Multiple IR Codes can be learnt against one Command in the CJSM2 IR set up menu. This enables multiple IR Codes to be transmitted through one Command in the CJSM2 when in IR mode.

Examples of use:

1. The on/off function for multiple appliances (the TV and the DVD for example) can be learnt against one entry in the IR Set up menu. The CJSM2 will then transmit the Codes for the learnt Command in one burst. In this case turning the TV and the DVD recorder on or off effectively simultaneously.
2. Previously selecting a TV channel required the user to select the individual channel's digits from a list. This could be quite cumbersome when trying to select a TV channel with multiple digits e.g. Channel 143. Now the individual Codes for "1", "4" and "3" can be learnt against one Command in the CJSM2 IR Set-up Menu. When this Command is selected the IR Codes are transmitted in the correct sequence.

To create a Sequence, relating to example 1 above:

- Select the Command to use as the Sequence initiator. In this example, TV > On/Off.
- Select Learn Code, by deflecting the joystick to the right while the Command is highlighted.
- Point the TV remote control at the CJSM2's Receiver LED and press the On/Off button twice.
- After each successful learn operation a check momentarily appears on the screen, select Learn Code again.
- Point the DVD remote control at the CJSM2's Receiver LED and press the On/Off button twice.
- After each successful learn operation a check momentarily appears on the screen, select Learn Code again.
- Complete the sequence by highlighting Exit and deflecting the joystick to the left.
- This time the On/Off Command will have a Tick and 3 Dots beside it, showing a Learnt Sequence. As displayed below.





## 6 ENABLING AND DISABLING IR CODES

IR Codes can be enabled or disabled in the IR Set-up Menu. If a Code is disabled it will not transmit and will not appear in IR Mode.

To disable an IR Code, deflect the speed paddle of the CJSM2 up or down. A disabled IR Code appears with an X against the highlighted Command.

To enable an IR Code, deflect the speed paddles on the CJSM2 up or down. An enabled Code appears with a check against the highlighted Command.



## 7 DELETING IR CODES

To delete an IR Code for a specific Command, highlight the specific Command in the Appliance menu and deflect the joystick to the right. Then select the Delete Code option.

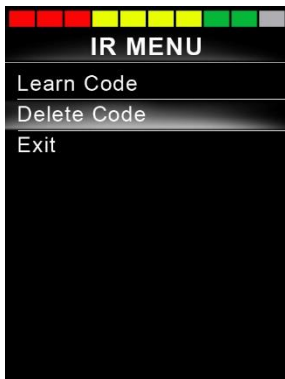



To delete all IR Codes for an Appliance select Delete All Codes within that Appliance's sub-menu.

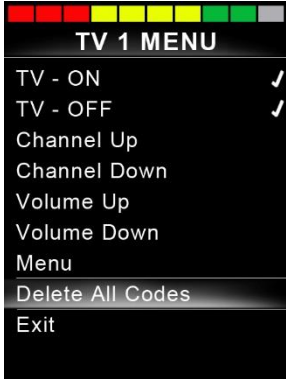

To delete all IR Codes stored in the CJSM2, select Delete All Codes within the IR Set-up Menu.





## CHAPTER 5 - IR CONFIGURATION TOOL

The IR configuration tool is a PC based application that allows the user to

- Read and Write IR menus from and to an R-net Control System
- Create IR User Menus.
- Change IR User Menus.
- Save IR User Menus.

### WARNING

**Programming and diagnostics should only be conducted by healthcare professionals with in-depth knowledge of Curtiss-Wright electronic Control Systems. Incorrect programming could result in an unsafe setup of a vehicle for a user. Curtiss-Wright accepts no liability for any losses of any kind if this condition is not met.**

The IR tool can be launched via the R-net PC programmer. Select the IR short cut on the toolbar menu or select IR Configurator from the tools drop down menu.

### NOTE

**Any IR Configuration Tool updates will be included in the overall updates of the R-net PC Programmer.**

**Pre-existing .RnIR and .RnIR2 files, opened in V.2.0 of the IR Configuration Tool, are automatically saved as .RnIR3 files. It is recommended that existing .RnIR and .RnIR2 files are re-saved with the file extension .RnIR3.**

## 1 OPERATION INITIATION

Upon opening the R-net PC programmer the following warning window will appear. It is important that this warning is read and understood before programming commences.

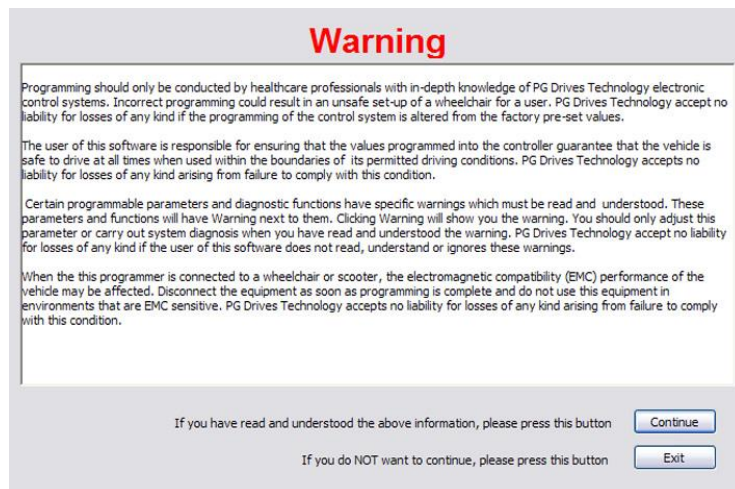

## 2 THE APPLICATION WINDOW

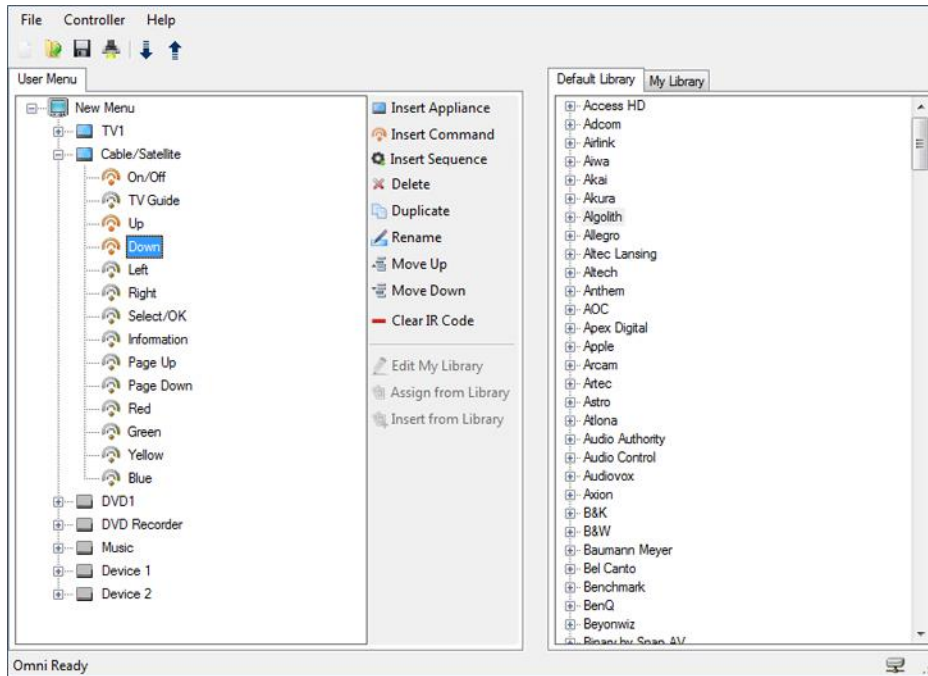

For ease of description the IR Configurator application will be separated into 4 different sections. These are:

- Drop-down Menus
- Toolbars
- User Menu
- Libraries

## 2.1 DROP-DOWN MENUS

### 2.1.1 FILE

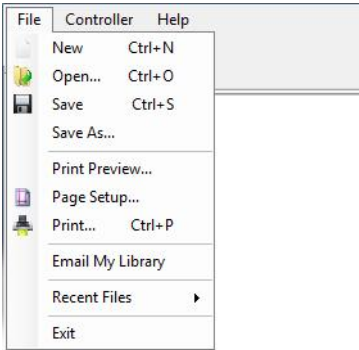

This menu contains standard Windows functions – New, Open, Save, Save As, Print Preview, Page Setup and Print, as well as Email My Library.

### 2.1.2 CONTROLLER

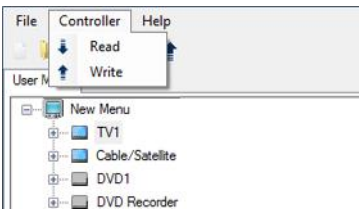

**Read** Reads and displays the IR menu (.RnIR3) file from the controller.

**Write** Writes the contents of the User Menu file to the controller.

### 2.1.3 HELP

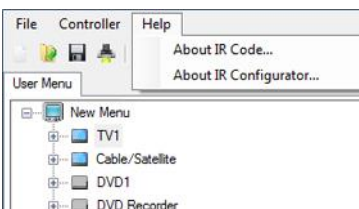

**About IR Code** This presents information relating to the current IR Library.

**About IR Configurator** This presents information relating to the software version of the IR Configurator.

## 2.2 TOOLBAR

The toolbar icons are shortcuts to the most regularly used functions within the drop-down menus.

## 2.3 USER MENU

This area displays and defines the User Menu structure. The User Menu is the list of Appliances and Commands available to the user when IR Control Mode is entered. Using the utilities: Insert Appliance, Insert Command, Insert Sequence, Delete, Duplicate, Rename, Move Up, Move Down, Clear IR Code, Assign from Library and Insert from Library, the menu structure and content can be changed.

The following screen shows an example User Menu with seven Appliances: TV1, Cable/Satellite, DVD1, DVD Recorder, Music, Device 1 and Device 2.

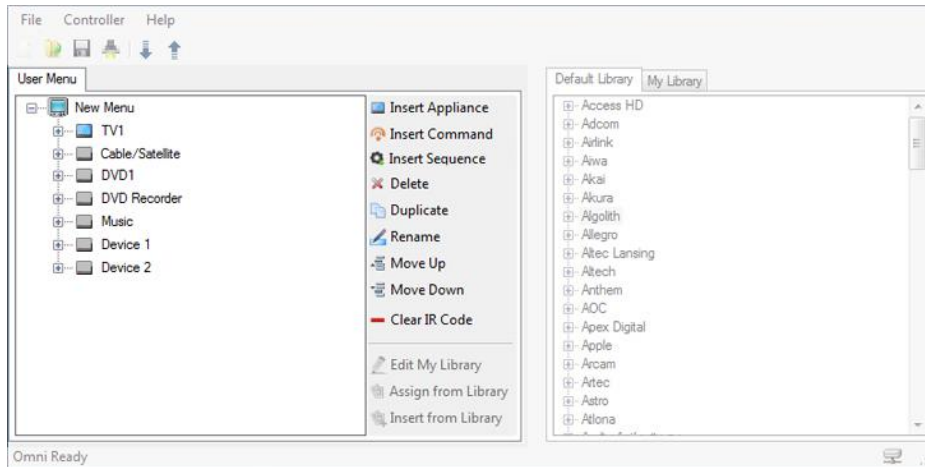

To view the Commands for each Appliance, click on the + symbol and the menu tree will expand. If a Command has an IR Code assigned to it, then the adjacent icon will be colored.

No Code

Code

### 2.3.1 INSERT APPLIANCE.

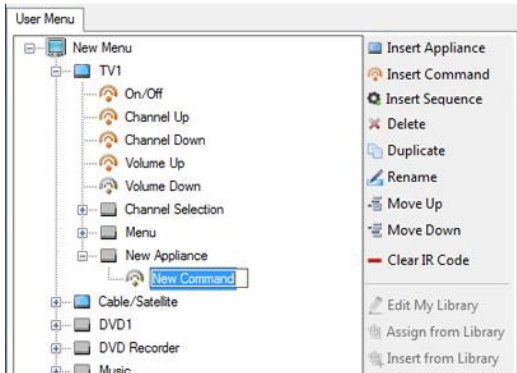

Inserts a new Appliance in the menu or within a sub-menu.

The text for the Appliance name is programmable.

### 2.3.2 INSERT COMMAND

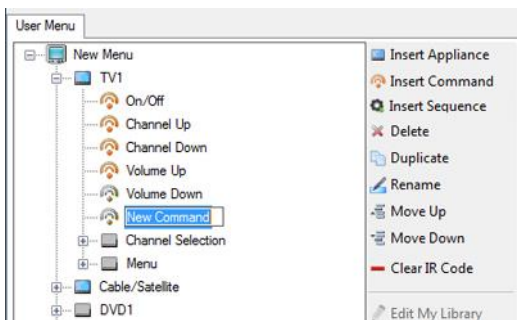

Inserts a new Command in the menu or within a sub-menu.

The text for the Command name is programmable.

### 2.3.3 INSERT SEQUENCE.

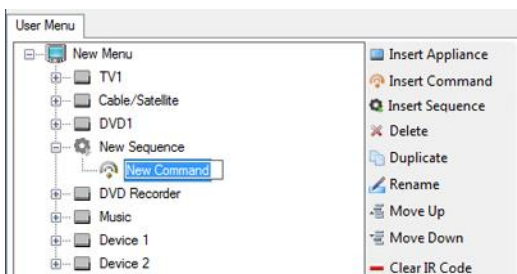

Inserts a new Sequence in the menu or within a sub-menu. The text for the Sequence name is programmable.

Creating a new Sequence enables multiple IR Codes to be assigned against one Command function in the CJSM2 User Menu.

Once a Sequence is created, Commands can be added or removed via Insert Command or Delete.

### 2.3.4 DELETE

Deletes the highlighted Appliance or Command from the User Menu.

### 2.3.5 RENAME

Allows the highlighted Appliance or Command to be renamed.

### 2.3.6 MOVE UP

Moves the highlighted Appliance or Command up within the User Menu structure.

Move Up operation can also be achieved through standard windows drag and drop functions.

### 2.3.7 MOVE DOWN

Moves the highlighted Appliance or Command down within the User Menu structure.

Move Down operation can also be achieved through standard windows drag and drop functions.

### 2.3.8 CLEAR IR CODE

To remove an IR Code from a Command in the User Menu, highlight that Command and click Clear IR Code. The IR Code will be cleared and the icon will change to Non-learnt Code.

### 2.3.9 EDIT MY LIBRARY

This function is only available when the My Library tab is selected, refer to the Libraries section for more details.

### 2.3.10 ASSIGN FROM LIBRARY

Assigns an IR Code from a highlighted Command in the Default Library or My Library to a highlighted Command in the User Menu.

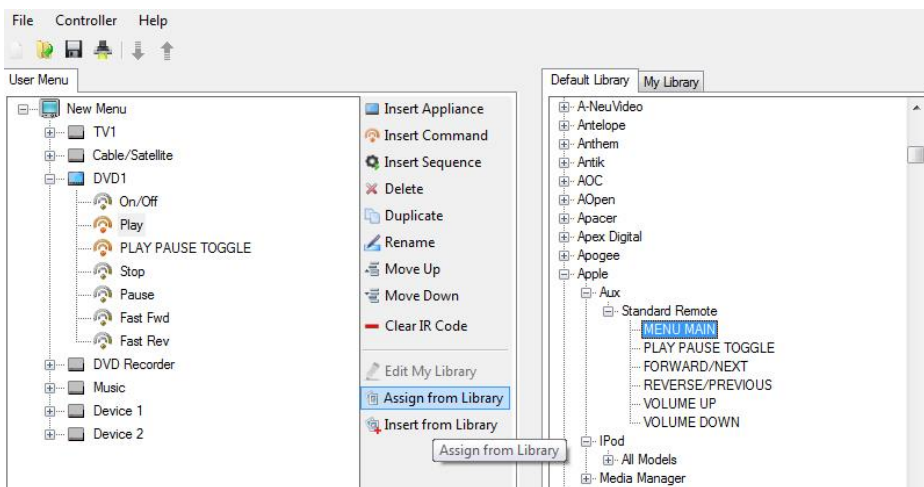

### 2.3.11 INSERT FROM LIBRARY

Inserts a highlighted Appliance or Command from the Default Library or My Library to the position beneath the highlighted Appliance or Command in the User Menu.

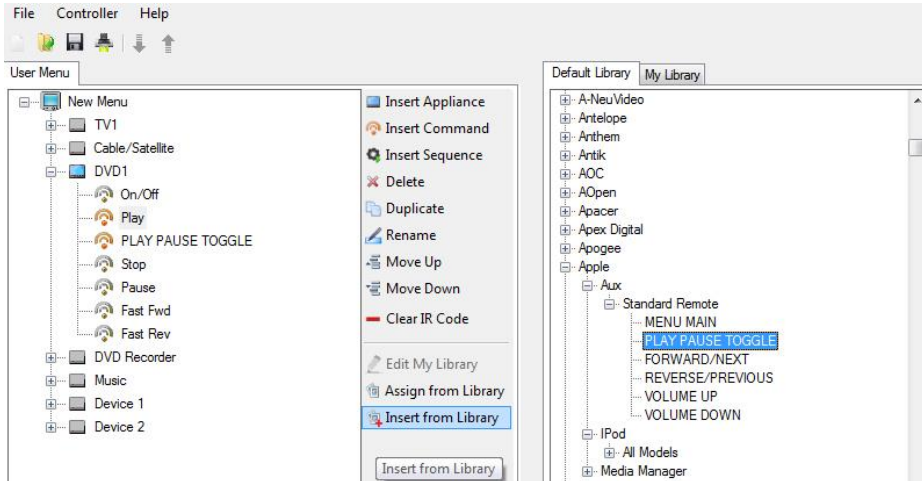

The resultant text in the User Menu will be as per the Library, but can be changed by using the Rename utility.

**NOTE**

**The Library is 'layered' as Brand > Product Type > Appliance > Command. It is only possible to insert from the Appliance level down.**

## 2.4 LIBRARIES

The Libraries area displays all the IR Codes available to the programmer on the PC that is being used.

For programmers wishing to build a library of Codes not found in the Default Library but often used in their region, the IR Tool has been designed with a separate depository called My Library.

It is possible to switch between libraries at any time, and use the Codes within, to build efficient User Menus.

**NOTE**

**The Library is 'layered' as Brand > Product Type > Appliance > Command. It is only possible to insert from the Appliance level down.**

### 2.4.1 DEFAULT LIBRARY

The IR Configurator is pre-loaded with a set of common IR Codes, these are found in the Default Library. Whilst this list is extensive it cannot cover every Code for every Appliance. An example screen can be seen below.

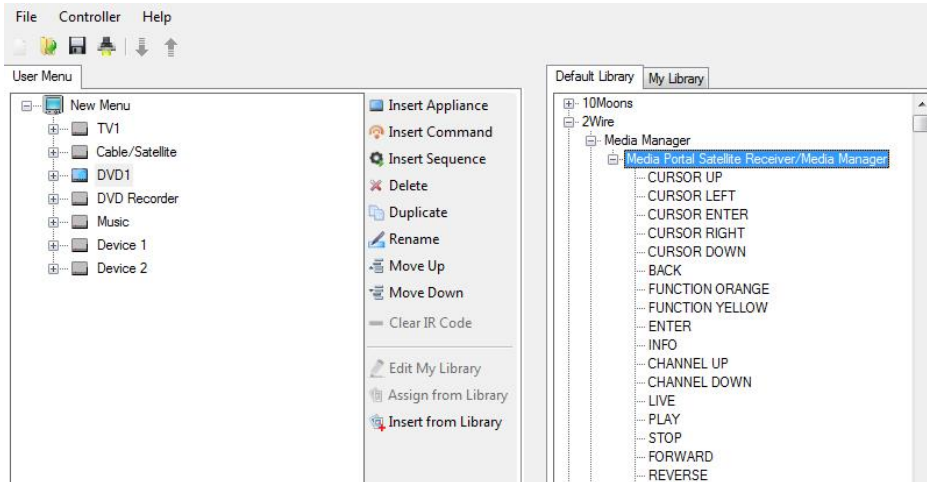

### 2.4.2 MY LIBRARY

The primary purpose of the My Library is to enable third-parties to supply Curtiss-Wright with IR Codes that are not included in the default library. IR Codes that are learned through the CJSM2 can be imported and saved via the My Library functions.

The contents of My Library are stored in a file called Mydatabase.sdf. The MyDatabase.sdf is stored within Program Data; C:\ProgramData\PG Drives Technology\IR Configurator

The MyDatabase.sdf file can be used by Curtiss-Wright to update the Default Library to include new Appliances and Commands.

Updates to the IR Configurator will be part of the ongoing upgrades to the R-net PC programmer.

MyDatabase.sdf files to be considered for inclusion in the Default Library should be emailed to Curtiss-Wright using the Email My Library function in the File drop-down menu.

To access the My Library Feature click on the My Library tab, then Click Edit My Library. Example screen is shown below.

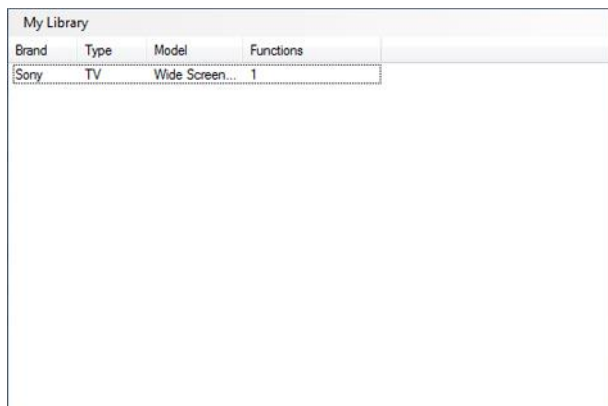

A drop-down menu, as shown below, can then be accessed.

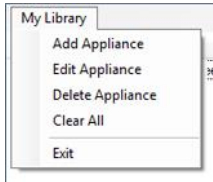

The following functions are available via the My Library drop-down menu:

- Add Appliance**                 Adds a new Appliance to the Library structure.
- Edit Appliance**               Edits the currently highlighted Appliance.
- Delete Appliance**           Deletes the currently highlighted Appliance from the Library structure.
- Clear All**                       Clears the My Library depository.

### 2.4.2.1     ADD APPLIANCE

To add a new Appliance click on Add Appliance in the drop-down menu, this will open the following window.

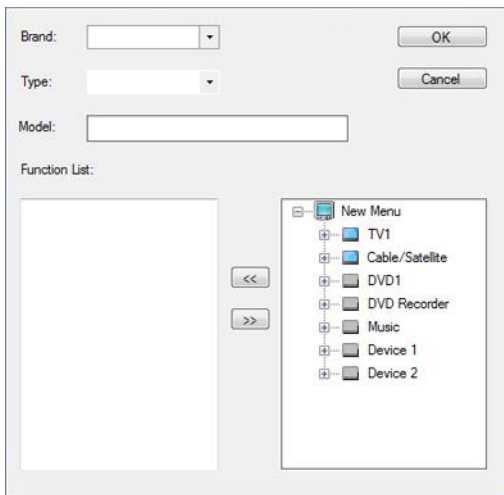

In this window it is possible to;

- Enter a Brand name
- Enter an Appliance Type
- Enter a Model description
- Select the Code(s) relevant for this application from the User Menu.

Use the << and >> buttons to add or remove Codes from the library structure.

**NOTE**

**Only Commands which have an IR Code can be added to the Function List.**

**Codes that are already within the Default Library cannot be added to the My Library structure.**

### 2.4.2.2 EDIT APPLIANCE

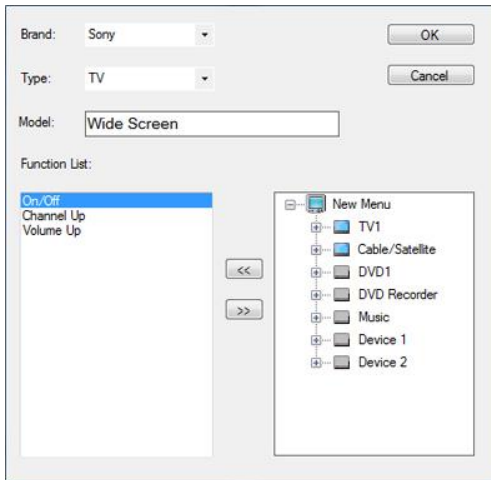

To Edit an Appliance select the Appliance from the list and either double click on the highlighted area or select Edit Appliance from the drop down menu.

This will open the Edit Appliance window with the selected Appliance details pre-loaded.

In this window it is possible to adjust all of the Appliances details and add or remove IR Codes.

### 2.4.2.3 DELETE APPLIANCE

To delete an Appliance and all its functions, highlight the unwanted Appliance and click Delete in the drop down menu.

### 2.4.2.4 CLEAR ALL

Clear All deletes all the Appliances and Commands within the My Library structure.



### 3 CURTISS-WRIGHT DEFAULT MENU

CJSM2 are shipped with default User Menu as below.

#### TV1

On/Off  
Channel Up  
Channel Down  
Volume Up  
Volume Down  
Channel Selection  
0  
1  
2  
3  
4  
5  
6  
7  
8  
0  
Input  
Select/OK

#### Cable/Satellite

On/Off  
TV Guide  
Up  
Down  
Left  
Right  
Select/OK  
Information  
Page Up  
Page Down  
Red  
Green  
Yellow  
Blue

#### DVD1

On/Off  
Play  
Stop  
Pause  
Fast Fwd  
Fast Rev

#### DVD Record

On/Off  
Play  
Stop  
Pause  
Fast Fwd  
Fast Rev  
Menu  
Up  
Down  
Left  
Right  
Select/OK  
Record  
Timer Record  
Record Mode

#### Music

On/Off  
Play  
Stop  
Volume Up  
Volume Down  
Pause  
Fast Fwd  
CD Changer  
AM  
FM  
Search  
Preset

#### Device 1

Command 1  
Command 2  
Command 3  
Command 4  
Command 5  
Command 6  
Command 7  
Command 8

#### Device 2

Command 1  
Command 2  
Command 3  
Command 4  
Command 5  
Command 6  
Command 7  
Command 8





## CHAPTER 6 – BLUETOOTH SET-UP & OPERATION

### 1 INTRODUCTION

The R-net CJS2M2-BT allows a wheelchair user to control multiple Bluetooth-enabled devices. Typical applications include PC mouse control or operation of a Smart device.

Up to four devices can be controlled. Two of which can be Apple iOS devices and two of which can be Windows or Android devices.

#### 1.1 OPERATIONAL RULES

Bluetooth Mode will only be available if one or more devices are set to On in the Settings Menu. See section Bluetooth Mode Screen Configuration for more details.

The CJS2M2-BT and target Bluetooth devices will remain paired until they are disconnected by the target device.

Once a CJS2M2-BT has been paired with a Bluetooth device, the module remembers the device’s unique identifier. This means the wheelchair can be driven outside the operating range of the Bluetooth connection and upon returning within range the connection will be automatically reinstated.

#### 1.2 SYSTEM CONFIGURATION

There are three configuration processes that need to be carried out – Bluetooth Mode configuration, the Bluetooth Mode screen configuration and pairing with Bluetooth Devices. Each is described in the following sections.

#### 1.3 BLUETOOTH MODE CONFIGURATION

An R-net Output Mode must be set to Bluetooth. For the purposes of this manual, the Mode Name will be assumed to be My Devices. See programing example below.

Profile Management	Profile 1	Profile 2	Profile 3
Configuration	Mode 1	Mode 2	Mode 3
Mode Name	Drive	Seating	Bluetooth 1
Input	Drive	Seating	Raw
Intermediate	None	None	None
Output	Drive	Seating	Bluetooth
Speeds	Profile 1	Profile 2	Profile 3
Controls			
Latched	Profile 1	Profile 2	Profile 3

Refer to R-net Technical Manual SK77981- Programming for more details.

## 1.4 BLUETOOTH MODE SCREEN CONFIGURATION

This is a two-stage process. Firstly, a device or devices must be set to On from the Settings Menu. Secondly, for each device a screen graphic and a name can be set via PC Programming. The following two sections describe each process.

### 1.4.1 SETTINGS MENU

Enter the Settings Menu, as described in the Operation chapter, and select Bluetooth.

A screen as below will appear.

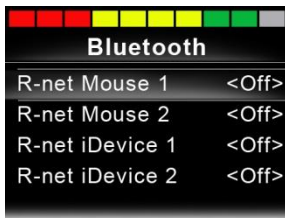

Set one or more of the devices to On. The R-net system must now be switched off and on again.

### 1.4.2 PC PROGRAMMER

There are four branches in the PC Programmer corresponding to the Bluetooth devices in the Settings Menu

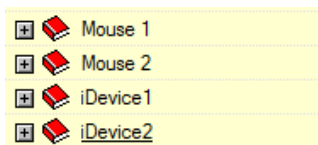

Within each branch, there are parameters called Device Name and Screen Graphic. These can be programmed to provide a more familiar name for a device and to set an appropriate screen symbol – a computer, a tablet or a cell phone – for the device. Refer to chapter Bluetooth Programming for more details.

For the remainder of this section, it will be assumed the Device Name parameters have been set per the following screen.

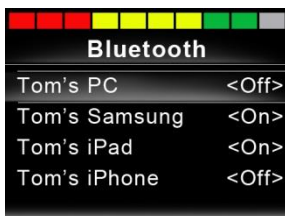

## 2 PAIRING WITH A BLUETOOTH DEVICE

The CJS2-BT must first be put into Discovery Mode via the sequence below.

- Enter Bluetooth Mode and select the device you wish to pair with.
- Deflect the joystick in the forward direction and hold until there is a beep. This will take approximately 10 seconds, then release.
- Deflect the joystick in the reverse direction and hold until there is a beep. This will take approximately 10 seconds, then release.

A screen such as below will appear – the flashing blue icon confirming the CJS2-BT is in Discovery Mode.



Depending on which type of device is being paired with – a Windows PC, an Android device or an iDevice – refer to one of the following three sections.

### 2.1 PAIRING WITH A WINDOWS PC

If the PC does not have integrated Bluetooth, then a receiver dongle must be used and its drivers installed.

PG Drives Technology recommends use of the following Bluetooth dongles:

- Trust BT-2400
- Linksys USBT100-UK
- Belkin F8T012uk1 Version 1000

Once a Bluetooth connection is confirmed, the following process should be undertaken on the PC:

Enter My Bluetooth Devices and a screen such as below should appear.



Click 'Add' to open the Bluetooth Device Wizard and a screen such as below should appear.



Check the box marked 'My device is set up and ready to be found'

Click 'Next', the PC will now search for local Bluetooth devices.

A screen such as below should appear.



Click on 'Tom's PC' and then click on 'Next'.

A screen such as below should appear. If a passkey is requested use 1234.



The PC will commence connection with the CJS2-BT and a screen such as below should appear.



When the connection is completed a screen such as below should appear.

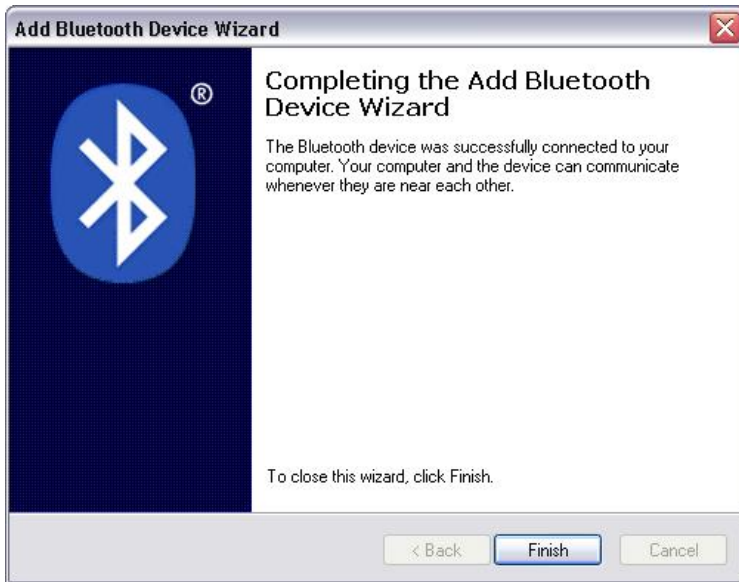

Click 'Finish', the blue icon on the CJSM2-BT should stop flashing.

A screen such as below should appear.



If the process fails, click on 'Tom's PC', then 'Remove' and repeat the process.



---

## 2.2 PAIRING WITH AN ANDROID DEVICE

The following process should be undertaken on the Android device:

- Select System Settings and set Bluetooth to On.
- Select 'Tom's Samsung' from the list available devices.
- Enter the password 'PGDT' (this is only required the first time the device is connected) when prompted on the screen.
- Open the R-net for Android App and select 'Connect'. This will present a list of available Bluetooth devices.
- Select 'Tom's Samsung' from the list of available devices.
- Enter the password '1234' when prompted on the screen.
- Tom's Samsung should appear as a paired device. In addition, the blue icon on the CJS2-BT should stop flashing.

---

## 2.3 PAIRING WITH AN IDEVICE

The following process should be undertaken on the iDevice:

- Select Settings and set Bluetooth to On.
- Select 'Tom's iPad' from the list of available devices.
- Tom's iPad should appear as a paired device. In addition, the blue icon on the CJS2-BT should stop flashing.

---

## 2.4 UPDATING THE LIST OF DEVICES

- The CJS2 will remember the Bluetooth ID of up to four devices. To replace an entry on the list of devices, one of the existing pairings must be terminated. This process is initiated from the paired device and will vary dependent on the type of device.
- Once the device is unpaired a new device can be added.

### 3 OPERATING A WINDOWS PC

The default programming relates to the operations shown below.

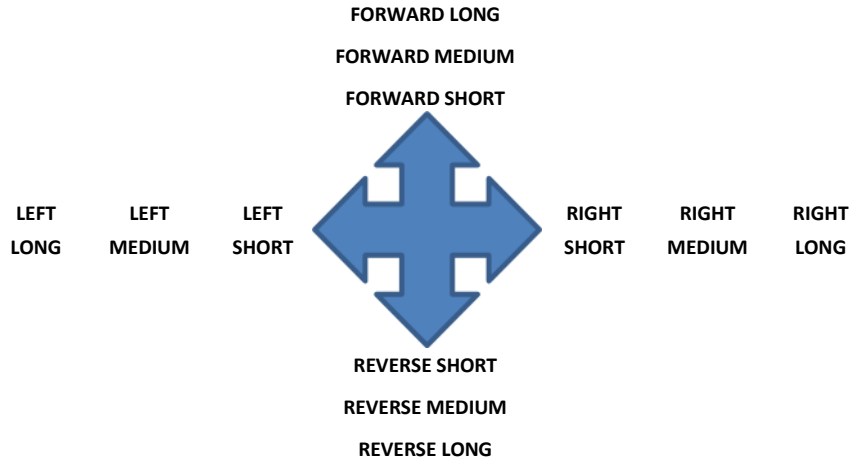

There are programmable options for the timings and sensitivity of the operations, refer to the Bluetooth Programming chapter for more information.

External switches connected to the External Profile jack socket can also be used to control devices, but programming of the R-net will be required. Refer to chapter Bluetooth Programming for more details.

### 4 OPERATING AN ANDROID DEVICE

The operating method is similar to that of a Windows PC and the same programmable options apply. Refer to the Bluetooth Programming chapter for more details.

#### 4.1 CONSIDERATIONS

The CJSM-BT cannot switch an Android device on or off.

The Sleep function of the Android device must be disabled.

If the device does 'go to sleep', then a manual wake-up process will be needed.

## 5 OPERATING AN IDEVICE

The CJSM2-BT can control an iDevice in two ways:

- Using the iDevice’s Switch Control functionality
- Using the iDevices Switch Control functionality in conjunction with the iDevices VoiceOver functionality

These two methods will be referred to as Switch Control and VoiceOver respectively, and each is explained in the following sections.

### 5.1 SWITCH CONTROL

The principle of Switch Control is that certain iDevice commands, such as the Home button or tapping the screen, can be assigned to commands received via Bluetooth from an external device such as the CJSM2-BT.

The process for assigning CJSM2-BT commands to the iDevice commands is covered in section Switch Control Set-Up.

An example of Switch Control is given below. Please note, the screen navigation sequences are defined by the iDevice and not the CJSM2-BT.

Switch Control operates by highlighting sections within the application window. Various commands are then used to navigate the sections and to select individual applications.

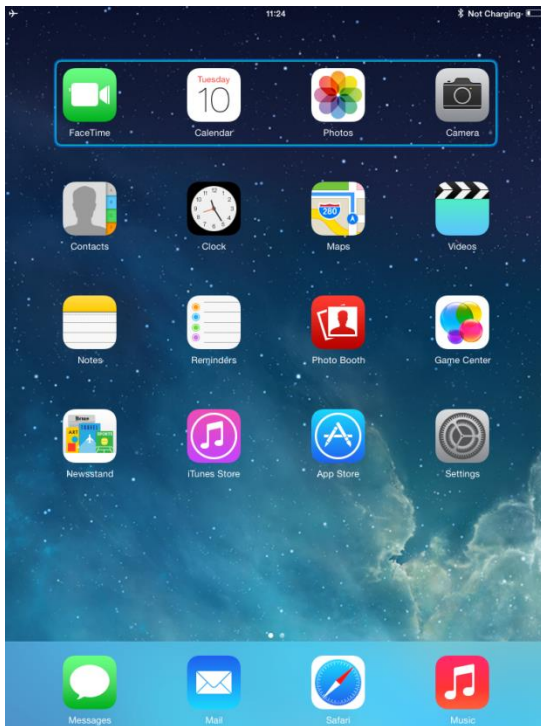

iDevice command Next Item selects another highlighted area.

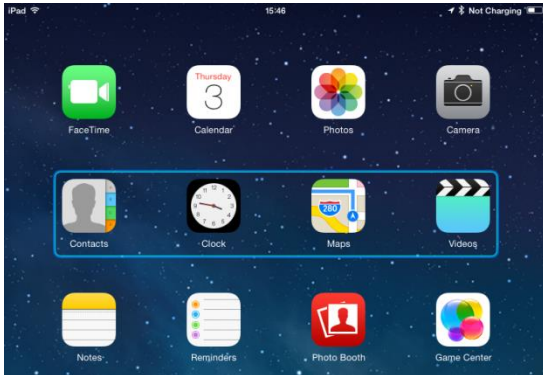

iDevice command Select Item enters the highlighted area.



iDevice commands Next Item and Previous Item are used to select individual icons within the highlighted area.

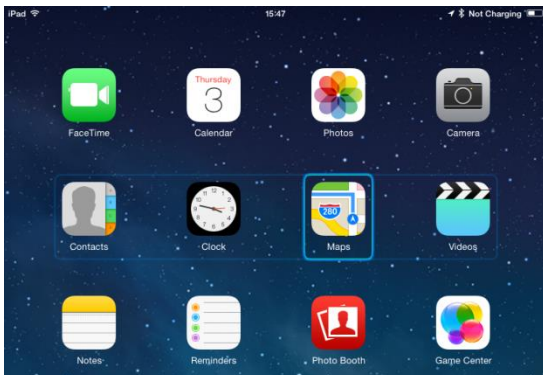

iDevice command Select Item opens the highlighted item. Depending on the nature of the application, areas of the screen will be highlighted and similar commands to the above can be used to navigate it.

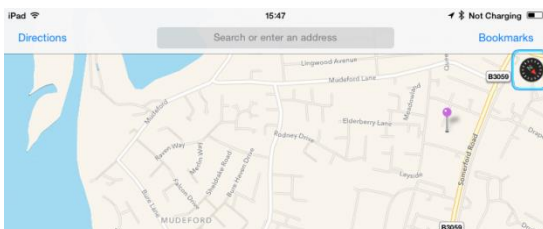

iDevice command Home returns to the Home screen.

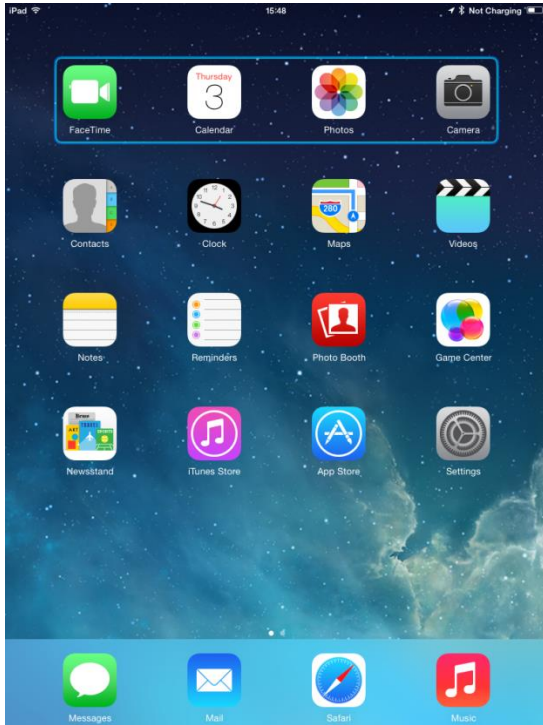

## 5.2 VOICEOVER

VoiceOver operates in conjunction with Switch Control, but offers an alternative method of screen navigation.

An example is given below. Please note, the screen navigation sequences are defined by the iDevice and not the CJS2-BT.

iDevice commands Cursor Right and Cursor Left select individual icons within a row.



The same iDevice commands also navigate the rows.

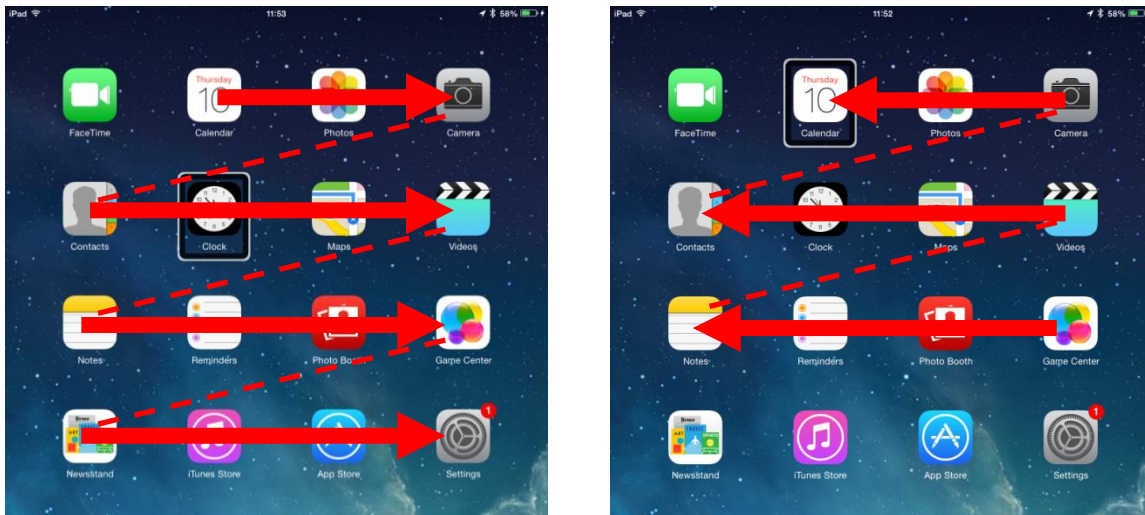

Opening items and returning to the Home screen are effected in the same way as Switch Control.

### 5.3 SWITCH CONTROL SET-UP

Certain CJSM2-BT commands can be assigned to iDevice commands. The CJSM2-BT commands are detailed below.

Time-related deflections (nudges) of the joystick in each of the four directions.

- Forward Short
- Reverse Short
- Left Short
- Right Short
- Forward Medium
- Reverse Medium
- Left Medium
- Right Medium
- Forward Long
- Reverse Long
- Left Long
- Right Long

The timings associated with the nudges are programmable. Refer to the Bluetooth Programming chapter for more information.

Set the R-net programmable parameter Mode to Switch Control. Refer to the Bluetooth Programming chapter for more information.

The procedure to enable Switch Control on the iDevice and assign commands is as follows.

From the iDevice Settings menu, select General > Accessibility.

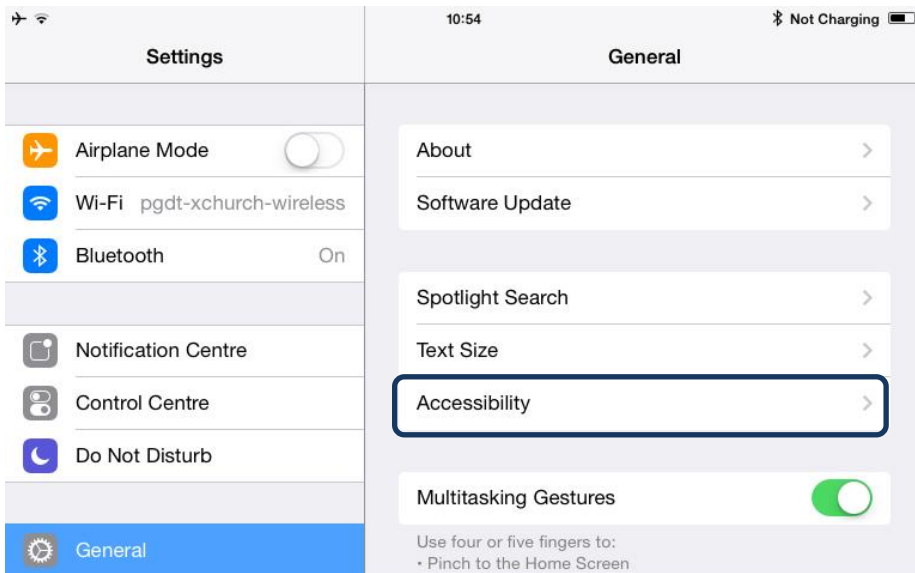

Set Switch Control to On.

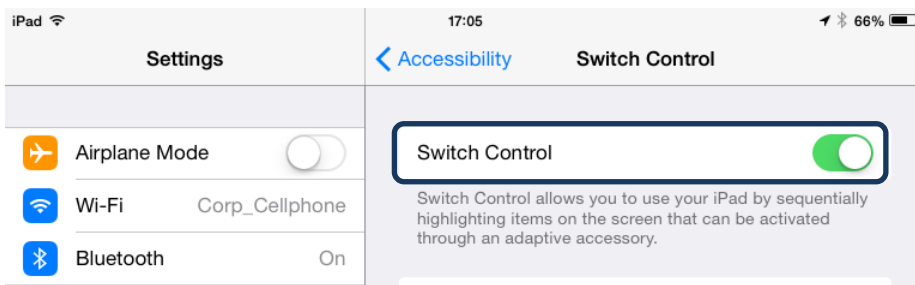

**NOTE**

**Within Accessibility there are Auto Scanning and Auto Hide options. It is recommended that these options are turned off for the initial set up.**

Select Switches.

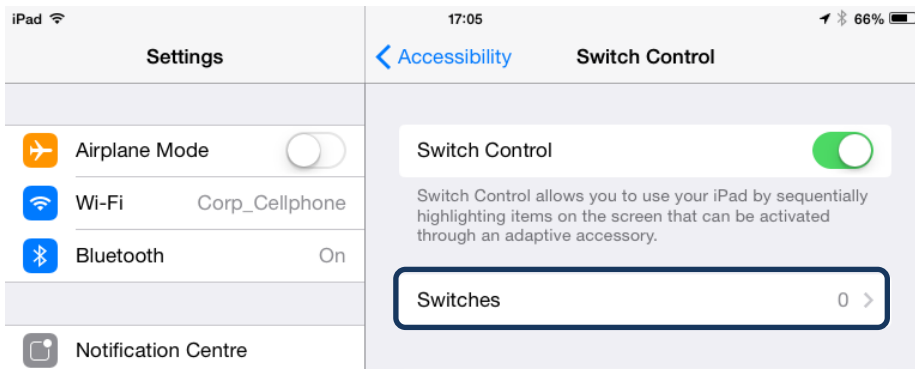



Select External.

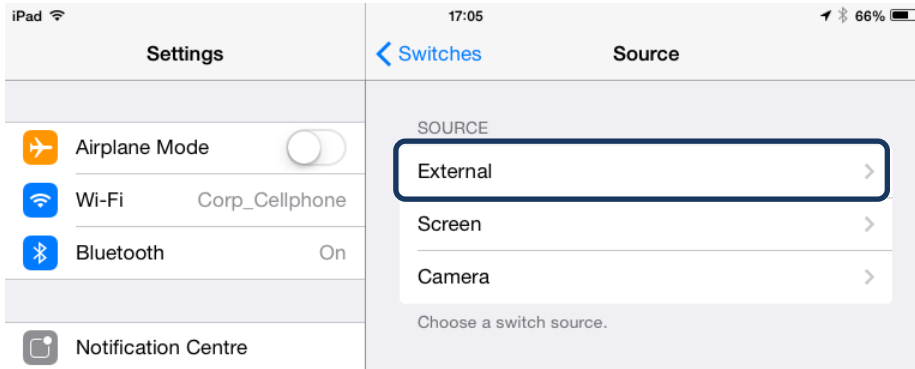

Select Add New Switch.

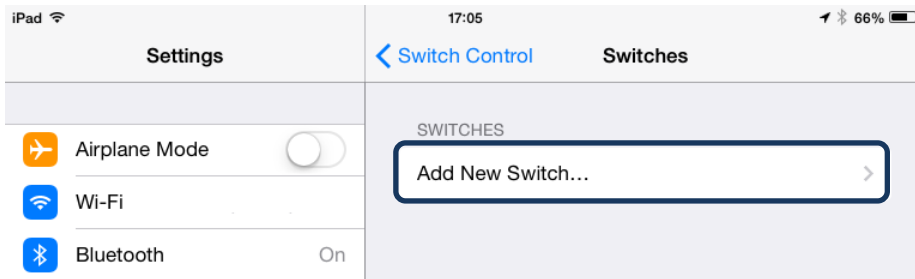

A screen such as below should appear.

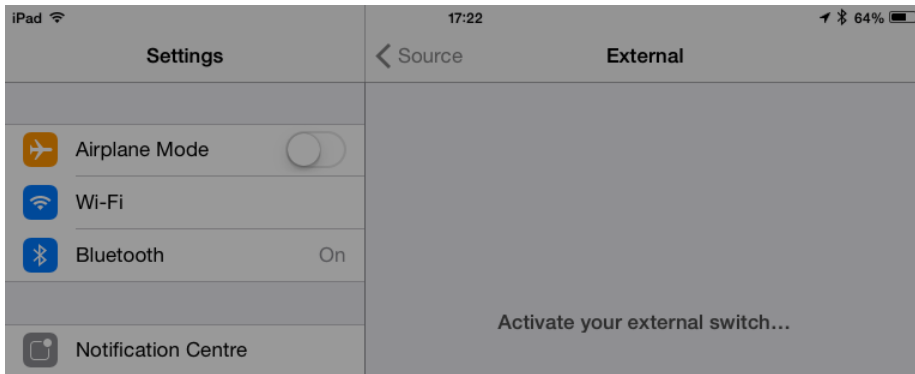

Activate the CJS2-BT command you wish to assign to the iDevice; for example, a long reverse nudge.

When the command has been received, a screen such as below will appear.



Enter a convenient name – for example, long reverse – and then Save.

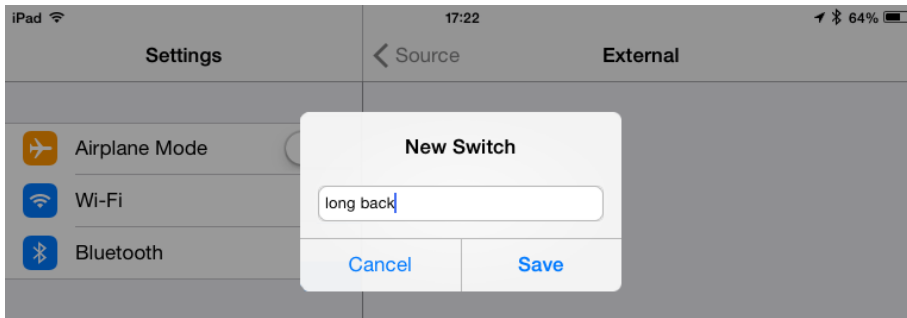

A screen such as below should appear.

Select the iDevice command you wish to assign; for example, Move To Next Item.

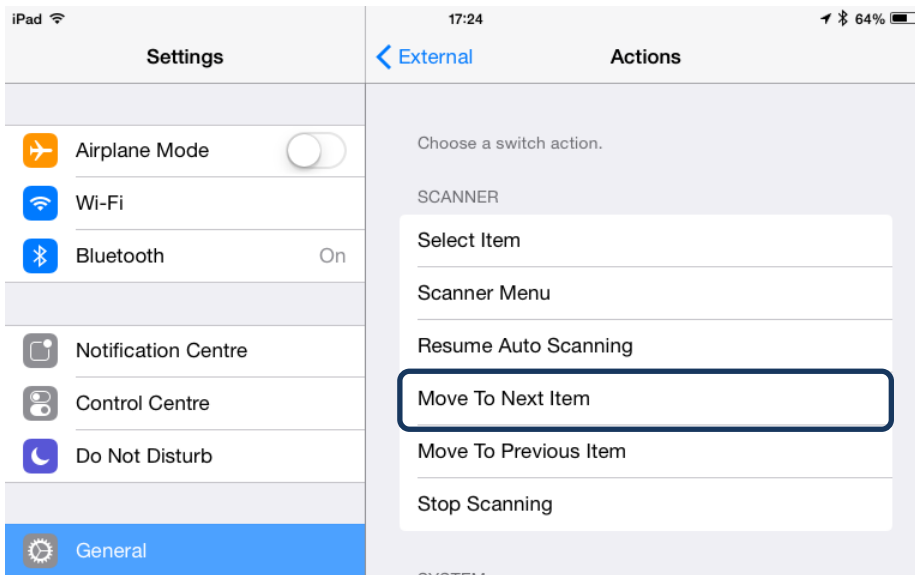

A screen such as below should appear and the process can be repeated to assign further commands.

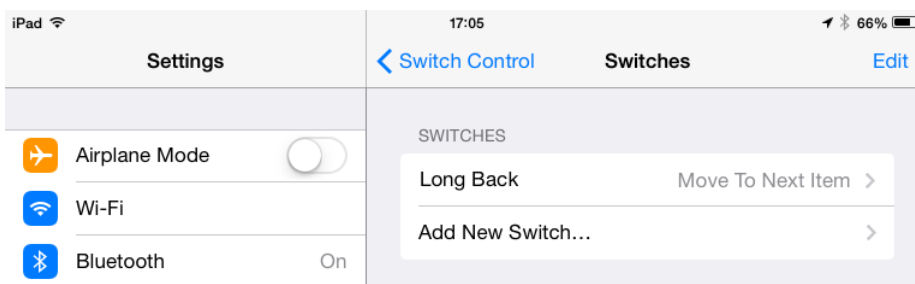

## 5.4 VOICEOVER SET-UP

Certain CJSM2-BT commands can be assigned to iDevice commands. These are detailed below.

Time-related deflections (nudges) of the joystick in each of the four directions.

- Forward Short
- Reverse Short
- Left Short
- Right Short
- Forward Medium
- Reverse Medium
- Left Medium
- Right Medium
- Forward Long
- Reverse Long
- Left Long
- Right Long

The timings associated with the nudges are programmable. Refer to the Bluetooth Programming chapter for more information.

Time-related operations of two external profile jack switches.

The timings associated with the external switch operations are programmable. Refer to the Bluetooth Programming chapter for more information.

The Speed Down and Speed Up buttons.

The procedure to enable VoiceOver on the iDevice and assign commands is as follows.

From the iDevice Settings menu, select General > Accessibility and set VoiceOver to On.

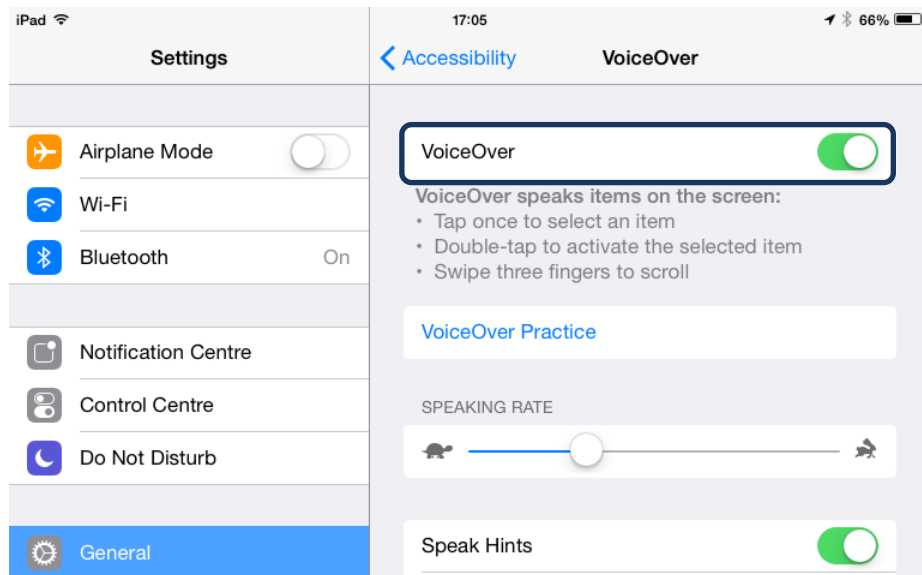

The remainder of VoiceOver set up is via the R-net PC programmer.

Firstly, set the parameter VoiceOver and then use the relevant parameters to assign CJSM2-BT to iDevice commands. Refer to the Bluetooth Programming chapter for more information.



## CHAPTER 7 – BLUETOOTH PROGRAMMING

### 1 INTRODUCTION

This section covers parameters which are specific to the Bluetooth operation of the CJS2-BT.

#### Mouse 1/Mouse 2

Forward Nudge	<i>Sets the action when the JS is deflected forward in mouse 1/2 mode</i>
Reverse Nudge	<i>Sets the action when the JS is deflected in reverse in mouse 1/2 mode</i>
Left Nudge	<i>Sets the action when the JS is deflected left in mouse 1/2 mode</i>
Right Nudge	<i>Sets the action when the JS is deflected right in mouse 1/2 mode</i>
Nudge Time	<i>Sets the time for a nudge to be active</i>
Pointer Speed	<i>Sets the maximum speed that the mouse pointer can be moved across the screen</i>
Pointer Acceleration	<i>Sets the time taken for the mouse pointer to reach its programmable setting of Pointer Speed</i>
Action Beeps	<i>Enables beeps on clicks on scroll functions</i>
Deflection beeps	<i>Enables beeps on deflection outside the deadband</i>
Double Click Time	<i>Sets the period of time during which two external switch operations must be detected</i>
External Switch Inputs	<i>Sets the action of an external switch connected to the CJS2</i>
Device Name	<i>Sets the name of the Mouse 1 module</i>
Screen Graphic	<i>Sets the screen graphic to be use in Bluetooth Mouse 1/2 process</i>

#### iDevice 1/iDevice 2

VoiceOver	
Forward Short	<i>Sets the action when the ID is deflected a forward short in iDevice 1/2 mode</i>
Reverse Short	<i>Sets the action when the ID is deflected a reverse short in iDevice 1/2 mode</i>
Left Short	<i>Sets the action when the ID is deflected a left short in iDevice 1/2 mode</i>
Right Short	<i>Sets the action when the ID is deflected a right short in iDevice 1/2 mode</i>
External Switch 1 Short	<i>Sets the action when the External Switch 1 is activated for a short period in iDevice1/2 mode</i>
External Switch 2 Short	<i>Sets the action when the External Switch 2 is activated for a short period in iDevice1/2 mode</i>
Forward Medium	<i>Sets the action when the ID is deflected a forward medium in iDevice 1/2 mode</i>
Reverse Medium	<i>Sets the action when the ID is deflected a reverse medium in iDevice 1/2 mode</i>
Left Medium	<i>Sets the action when the ID is deflected a left medium in iDevice 1/2 mode</i>
Right Medium	<i>Sets the action when the ID is deflected a right medium in iDevice 1/2 mode</i>
External Switch 1 Medium	<i>Sets the action when the External Switch 1 is activated for a medium period in iDevice 1/2 mode</i>
External Switch 2 Medium	<i>Sets the action when the External Switch 2 is activated for a medium period in iDevice 1/2 mode</i>
Forward Long	<i>Sets the action when the ID is deflected a forward long in iDevice 1/2 mode</i>
Reverse Long	<i>Sets the action when the ID is deflected a reverse long in iDevice 1/2 mode</i>
Left Long	<i>Sets the action when the ID is deflected a left long in iDevice1/2 mode</i>
Right Long	<i>Sets the action when the ID is deflected a right long in iDevice 1/2 mode</i>
External Switch 1 Long	<i>Sets the action when the External Switch 1 is activated for a long period in iDevice 1/2 mode</i>
External Switch 2 Long	<i>Sets the action when the External Switch 2 is activated for a long period in iDevice 1/2 mode</i>
Action Beeps	<i>Enables beeps on clicks or scroll functions</i>
Deflection beeps	<i>Enables beeps on deflection outside the deadband</i>
Short Nudge Time	<i>Sets the time for a short nudge or period to be active</i>
Medium Nudge Time	<i>Sets the time for a medium nudge or period to be active</i>
Long Nudge Time	<i>Sets the time for a long nudge or period to be active</i>
Device Name	<i>Sets the name of the iDevice module</i>
Mode	<i>Sets the mode for the iDevice module</i>
Screen Graphic	<i>Sets the screen graphic to be use in Bluetooth iDevice process</i>



---

## MOUSE 1/MOUSE 2

---

### 1.1 FORWARD, REVERSE, LEFT & RIGHT NUDGE

Programming Nudge allows the user to activate a click of the mouse without having to activate a key on an Input Device.

In Bluetooth Mode a Nudge is a quick activation of the Input Device in the Forward, Reverse, Left or Right directions. Activating the Input Device in a particular direction can be set to a particular mouse function.

The programmable options are as follows:

None – No Mouse click will be initiated.

Left Click – A Left Mouse click will be initiated.

Right Click – A Right Mouse click will be initiated.

Scroll Up – A mouse wheel Up operation is initiated when within an appropriate program.

Scroll Down – A mouse wheel Down operation is initiated when within an appropriate program.

Double Click Left – A left double click operation will be initiated.

Double Click Right – A right double click operation will be initiated.

Android OS Home – Return to the home screen on a smartphone or tablet that used the Android OS.

Android OS Back – Return to the previously selected screen on a smartphone or tablet that uses the Android OS.

Android OS Volume Up – Turns the volume Up on a smartphone or tablet that uses Android OS.

Android OS Volume Down – Turns the volume Down on a smartphone or tablet uses the Android OS.

---

### 1.2 NUDGE TIME

The parameter Nudge Time sets the time limit in which an Input Device must be deflected and released to activate a mouse command.

The Parameter Nudge Time is programmable between 0 and 5 seconds in steps of 20ms. Setting Nudge Time to 0 disables Nudge support.

---

### 1.3 POINTER SPEED

Pointer Speeds sets the maximum speed that the mouse pointer can be moved across the screen.

This parameter is programmable between 0 and 100% in steps of 1%.

Setting the Pointer Speed to 0% will disable mouse pointer movement, and change the functionality for both proportional and switched Input Devices: Deflecting the Input Device will cause the action associated with that direction to be executed immediately, irrespective of the Nudge Time parameter.



If the action of the Input Device is programmed to a mouse button, a button operation will be assumed and will remain assumed for as long as the input device is held deflected in that direction.

If the action of the Input Device is programmed to a scroll movement, a scroll movement will be performed and will auto-repeat every 200ms for as long as the Input Device is held deflected in that direction.

This could be useful for wheelchair users that have limited motor control and use Input Devices such as head arrays, switch inputs or sip & puff. Single input commands can therefore be used to activate and repeat a mouse click or scroll function.

---

#### 1.4 POINTER ACCELERATION

For non-proportional Input Devices, Pointer Acceleration sets the time taken for the mouse pointer to reach its programmable setting of Pointer Speed.

The parameter is programmable between 20ms and 5s in steps of 20ms.

---

#### 1.5 ACTION BEEPS

This parameter sets whether the user gets a continuous set of beeps whilst an Input Device is being used to control a mouse, e.g. moving the mouse across the screen

This parameter can be set to Yes or No

---

#### 1.6 DEFLECTION BEEPS

This parameter sets whether the user gets a single beep whilst an Input Device is being used to control a mouse button function, e.g. Nudge functions such as Right Click.

This can be set to Yes or No

---

#### 1.7 DOUBLE CLICK TIME

This sets the period of time during which two external switch operations must be detected, in order to be interpreted as a double-click.

The programmable range is 0s to 2.5s in steps of 0.1s

If set to 0s, then no double-click facility will be supported. This setting should be used if accidental double-clicks are a problem.

If set to any other value, then this is the period that two User Switch operations must be made, in order to be interpreted as a double-click.

---

#### 1.8 BLUETOOTH EXTERNAL SWITCHES

The external Profile Jack function can be programmed to enables Bluetooth functions to be assigned to external switch inputs. With Bluetooth External Switches set to On, in Mouse 1 and 2 the programmable options are



None - No Mouse click will be initiated.

Left Click – A Left Mouse click will be initiated.

Right Click – A Right Mouse click will be initiated.

Scroll Up – A mouse wheel Up operation is initiated when within an appropriate program.

Scroll Down – A mouse wheel Down operation is initiated when within an appropriate program.

Double Click Left – A left double click operation will be initiated.

Double Click Right – A right double click operation will be initiated.

Android OS Home – Return to the home screen on a smartphone or tablet that used the Android OS

Android OS Back – Return to the previously selected screen on a smartphone or tablet that uses the Android OS

Android OS Volume Up – Turns the volume Up on a smartphone or tablet that uses Android OS

Android OS Volume Down– Turns the volume Down on a smartphone or tablet uses the Android OS

---

### 1.9 DEVICE NAME

This is a text string that will appear on the CJSM2-BT LCD screen to indicate the active Bluetooth Mode.

---

### 1.10 SCREEN GRAPHIC

Sets the screen graphic for mouse mode, the programmable options are Computer, Phone or Tablet.



Computer



Phone



Tablet



---

## IDEVICE 1/IDEVICE 2

---

### 1.11 VOICEOVER

This section contains the commands and their functions that work only with VoiceOver mode, to allow full navigation of a connected iDevice. Below are the default commands:

---

#### 1.11.1 FORWARD, REVERSE, LEFT, RIGHT, EXTERNAL SWITCH 1 & EXTERNAL SWITCH 2 SHORT

These represent the functions associated with Short commands in VoiceOver mode.

The programmable options are as follows:

No Action – No action will be initiated.

Cursor Left – The screen cursor will move to the left by one application.

Cursor Right – The screen cursor will move to the right by one application.

Select – The highlighted application or item will be selected (equivalent to a double tap).

App Switcher – This presents the App Switcher screen.

Toggle Virtual Keyboard – This will show or hide the virtual keyboard.

Back – In Safari, goes back to previous page.

Home – This will select the Home screen.

Quick Nav – Allows navigation using arrow keys (left and right cursor)

Volume Up – This will increase the volume.

Volume Down – This will decrease the volume.

Double Click Right – A right double click operation will be initiated.

Any action that is not programmed will remain as the default setting.

#### NOTE

**When keyboard is visible, Back command toggles between split keyboard and normal keyboard.**

---

#### 1.11.2 FORWARD, REVERSE, LEFT, RIGHT, EXTERNAL SWITCH 1 & EXTERNAL SWITCH 2 MEDIUM

These represent the functions associated with Medium commands in VoiceOver mode.

The programmable options are as follows:

No Action – No action will be initiated.

Cursor Left – The screen cursor will move to the left by one application.

Cursor Right – The screen cursor will move to the right by one application.



Select – The highlighted application or item will be selected (equivalent to a double tap).

App Switcher – This presents the App Switcher screen.

Toggle Virtual Keyboard – This will show or hide the virtual keyboard.

Back – In Safari, goes back to previous page.

Home – This will select the Home screen.

Quick Nav – Allows navigation using arrow keys (left and right cursor)

Volume Up – This will increase the volume.

Volume Down – This will decrease the volume.

Double Click Right – A right double click operation will be initiated.

Any action that is not programmed will remain as the default setting.

#### NOTE

**When keyboard is visible, Back command toggles between split keyboard and normal keyboard.**

---

### 1.11.3 FORWARD, REVERSE, LEFT, RIGHT, EXTERNAL SWITCH 1 & EXTERNAL SWITCH 2 LONG

These represent the functions associated with Long commands in VoiceOver mode.

The programmable options are as follows:

No Action – No action will be initiated.

Cursor Left – The screen cursor will move to the left by one application.

Cursor Right – The screen cursor will move to the right by one application.

Select – The highlighted application or item will be selected (equivalent to a double tap).

App Switcher – This presents the App Switcher screen.

Toggle Virtual Keyboard – This will show or hide the virtual keyboard.

Back – In Safari, goes back to previous page.

Home – This will select the Home screen.

Quick Nav – Allows navigation using arrow keys (left and right cursor)

Volume Up – This will increase the volume.

Volume Down – This will decrease the volume.

Double Click Right – A right double click operation will be initiated.

Any action that is not programmed will remain as the default setting.

#### NOTE

**When keyboard is visible, Back command toggles between split keyboard and normal keyboard.**



---

### 1.12 ACTION BEEPS

This parameter sets whether the user gets a continuous set of beeps whilst an Input Device is being used to control a mouse, e.g. moving the mouse across the screen

This parameter can be set to Yes or No

---

### 1.13 DEFLECTION BEEPS

This parameter sets whether the user gets a single beep whilst an Input Device is being used to control a mouse button function, e.g. Nudge functions such as Right Click.

This can be set to Yes or No

---

### 1.14 SHORT NUDGE TIME

The parameter Short Nudge Time sets the time limit in which a Input Device must be deflected and released to activate a Short command.

The Parameter Short Nudge Time is programmable between 0 and 2 seconds in steps of 100ms.

The default value for Short Nudge Time is 0.5s.

---

### 1.15 MEDIUM NUDGE TIME

The parameter Medium Nudge Time sets the time limit in which a Input Device must be deflected and released to activate a Medium command.

The Parameter Medium Nudge Time is programmable between 0 and 3 seconds in steps of 100ms.

The default value for Medium Nudge Time is 2.0s.

#### NOTE

**Medium Nudge Time must be programmed to a value greater than Short Nudge Time.**

---

### 1.16 LONG NUDGE TIME

The parameter Long Nudge Time sets the time limit in which a Input Device must be deflected and released to activate a Long command.

The Parameter Long Nudge Time is programmable between 0 and 5 seconds in steps of 100ms.

The default value for Long Nudge Time is 3.0s.

#### NOTE

**Long Nudge Time must be programmed to a value greater than Medium Nudge Time.**

---

**1.17      DEVICE NAME**

This is a text string that will appear on the CJSM2 LCD screen to indicate the active Bluetooth Mode.

---

**1.18      MODE**

The parameter Mode sets the mode of operation for the iDevice module.

The programmable options are as follows:

VoiceOver – The iDevice will use VoiceOver mode on the connected iDevice.

Switch Control – The iDevice module will use Switch Control mode on the connected iDevice.

---

**1.19      SCREEN GRAPHIC**

Sets the screen graphic for mouse mode, the programmable options are Computer, Phone or Tablet.



Computer



Phone



Tablet



## CHAPTER 8 - SPECIFICATIONS

### 1 ELECTRONIC SPECIFICATIONS

Supply Voltage: 24Vdc  
Operating Voltage: 16Vdc to 35Vdc  
Operating Range: 10 Meters  
Charger Connector: Use only Neutrik NC3MX  
Battery Charging Current: 12Arms max.  
Moisture Resistance: Electronics to IPX4

Operating Temperature: -10°C to 50°C  
Storage Temperature: -20°C to 65°C

EMC tested on sample wheelchair:

Susceptibility: Tested at 30V/m to EN12184 and ANSI/ RESNA requirements  
Emissions: To EN55022 Class B  
ESD: IEC801 part 2

For complete electrical specifications of the R-net Control System, refer to the R-net Technical Manual SK77981.



## 2 BLUETOOTH REGULATORY REQUIREMENTS

This product contains a Class 2 Bluetooth transmitter device with a range of up to 10 meters

If the product is used in areas where mobile phones are required to operate in a flight-safe mode, then the Bluetooth transmitter should be temporarily disabled as described in the product technical manual.

The Bluetooth controller must only be used for the intended purpose as explained in the product technical manual. It must not be used in any safety-critical, life-supporting, or life-sustaining applications.

### 2.1 RISK ASSESSMENT INFORMATION

#### 2.1.1 RSA 1.1:

The Bluetooth controller must only be used for the intended purpose as explained in the product technical manual. It must not be used in any safety-critical, life-supporting, or life-sustaining applications.

#### 2.1.2 RSA 2.2 & RSA 4.2:

This product contains a Class 2 Bluetooth transmitter device with a range of up to 10 meters. If the product is used in areas where mobile phones are required to operate in a “flight safe” mode, then the Bluetooth transmitter should be temporarily disabled as described in the product technical manual.

### 2.2 FDA LABELLING REQUIREMENTS

#### 2.2.1 DEVICE FUNCTIONALITY:

The R-net CJSM2-BT is a Joystick Module that includes a Bluetooth Module in order to allow a wheelchair user to control non-safety-critical functions of external equipment such as PCs and smart devices.

The R-net CJSM2-BT communicates with external equipment using a Class 2 Bluetooth HID transmitter.

#### 2.2.2 OPERATING CHARACTERISTICS:

The operating characteristics of the wireless transmitter in the product are summarised in the table below.

Wireless technology	Bluetooth v2.1 + Enhanced Data Rate
Transfer Power	+4dBm, Class 2
Range	10m
Frequency range	2.402GHz - 2.48GHz
Modulation	GFSK
Max data rate	3.0Mbps
Bluetooth Profile (protocol)	HID (keyboard only)



### 2.2.3 QUALITY OF SERVICE (QOS):

The QoS risks for this product are negligible if used for the intended purpose. See trouble shooting section for advice in establishing a reliable connection.

### 2.2.4 WIRELESS SECURITY MEASURES:

Note: Bluetooth transfers are not encrypted. This should not pose a security risk to the if the product is used for the intended purpose.

### 2.2.5 ADDRESSING WIRELESS ISSUES:

See troubleshooting Bluetooth Set-up and Operation chapter.

### 2.2.6 COEXISTENCE ISSUES:

It is anticipated that the product will be used in the vicinity of other non-medical devices which share the 2.4GHz area of the radio spectrum. The Bluetooth protocol supports the Frequency Hopping Spread Spectrum (FHSS) technique, which will help to mitigate co-existence issues due to interference. The bluetooth transmitter in this product is approved for conformance to the Bluetooth protocols by the Bluetooth Special Interest Group (Bluetooth SIG). For further information see [https://www.bluetooth.org/tpg/QLI\\_viewQDL.cfm?qid=30976](https://www.bluetooth.org/tpg/QLI_viewQDL.cfm?qid=30976).

Where the product is to be operated in the vicinity of medical devices which use a proprietary protocol in the 2.4GHz spectrum, refer to chapter Bluetooth Set-up & Operations for information about flight-safe mode operation.

### 2.2.7 EMC AND TELECOMMUNICATIONS STANDARDS:

Certifications for FCC, CE, Bluetooth SIG.

### 2.2.8 WARNING REGARDING USE IN THE VICINITY OF RF SOURCES:

Not Applicable. The wireless functionality in this product is neither life-sustaining or life-supporting.

## 2.3 REGULATORY INFORMATION

### 2.3.1 UNITED STATES

Contains transmitter module FCC ID: T9J-RN42

This equipment has been tested and found to comply with the limits for a Class B digital device, pursuant to part 15 of the FCC Rules. These limits are designed to provide reasonable protection against harmful interference in a residential installation. This equipment generates, uses and can radiate radio frequency energy, and if not installed and used in accordance with the instructions, may cause harmful interference to radio communications. However, there is no guarantee that interference will not occur in a particular installation. If this equipment does cause harmful interference to radio or television reception, which can be determined by turning the equipment off and on, the user is encouraged to try to correct the interference by one or more of the following measures:



- Reorient or relocate the receiving antenna.
- Increase the separation between the equipment and receiver.
- Connect the equipment into an outlet on a circuit different from that to which the receiver is connected.
- Consult the dealer or an experienced radio/TV technician for help.

### 2.3.2 CANADA

RN42: Contains transmitter module IC: 6514A-RN42

This device complies with Industry Canada license-exempt RSS standard(s). Operation is subject to the following two conditions: (1) this device may not cause interference, and (2) this device must accept any interference, including interference that may cause undesired operation of the device.

Le présent appareil est conforme aux CNR d'Industrie Canada applicables aux appareils radio exempts de licence. L'exploitation est autorisée aux deux conditions suivantes: (1) l'appareil ne doit pas produire de brouillage, et (2) l'utilisateur de l'appareil doit accepter tout brouillage radioélectrique subi, même si le brouillage est susceptible d'en compromettre le fonctionnement.

### 2.3.3 EUROPE

**CE0681**

### 2.3.4 JAPAN

Contains transmitter module with certificate number:



### 2.3.5 KOREA

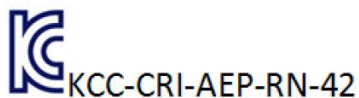

### 2.3.6 TAIWAN

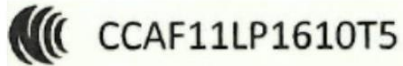

#### 注意！

依據 低功率電波輻射性電機管理辦法

第十二條 經型式認證合格之低功率射頻電機，非經許可，公司、商號或使用者均不得擅自變更頻率、加大功率或變更原設計之特性及功能。

第十四條 低功率射頻電機之使用不得影響飛航安全及干擾合法通信；經發現有干擾現象時，應立即停用，並改善至無干擾時方得繼續使用。

前項合法通信，指依電信規定作業之無線電信。

低功率射頻電機須忍受合法通信或工業、科學及醫療用電波輻射性電機設備之干擾。

